

2020



COMMUNITY

Arena Services and Supplies

YOUR DASHBOARD AND ARENA SUPPLIES PARTNER



CONVERSION



COLLEGIATE

Athletica
SPORT SYSTEMS
Safety through innovation



CREATING CHAMPIONS, EVERYWHERE.

Athletica Sport Systems has recently acquired Cascadia Sport Systems and Becker Arena Products; both are premium providers of dasher board systems and arena aftermarket products. Utilizing the best of these three incredibly successful organizations results in exceptional product offerings, expanded industry experience, and enhanced business relationships for our customers world-wide.

Our shared vision and values remain the same. We will lead the industry in bringing safe, innovative products to market underpinned by superior customer service.

Safety Through Innovation

Here at Athletica Sport Systems, we believe in safety through innovation. Our philosophy has seen us become the world leader in the design, engineering, innovation, manufacture, distribution, installation and service of dasher board systems.

Our designs improve player safety, fan experience, and reduce owner liability.

As a preferred rink equipment supplier to the National Hockey League®, the American Hockey League, and USA Hockey, we work closely with the leagues to ensure new product enhancements such as our unique seamless acrylic shielding system, our patented SoftCap® safety cap rail system and GlassFlex®, our flexible shielding system, are aligned with their current mandates and regulations.

Athletica Sport Systems is headquartered in Waterloo, Ontario, where our manufacturing and main distribution facility is located; we have an additional sales, service and distribution centers in Minneapolis, Minnesota and Vancouver, British Columbia as well as sales distribution around the world.

When it comes to excellence in sports facilities, no other company comes close to Athletica Sport Systems.

Whether it's enhancing the physical safety of players, reducing risk and liability for rink owners; improving ease of conversions, or maximizing the game experience for spectators - we bring it all to the game of hockey.

Our service and installation teams have completed over 3,000 projects - no company in the world builds more dasher board systems than Athletica Sport Systems, and nobody builds them better.

TABLE OF CONTENTS

SERVICE SCHEDULES

Servicing your Arena Boards	5
-----------------------------	---

GOAL PACKAGES

Goal Packages	6 - 7
---------------	-------

GOAL ACCESSORIES

Goal Net and Pad Packages	8
Goal Netting and Goal Pads	9
Goal Net Protectors	10
Goal Pegs and Accessories	11 - 12

RINK MAINTENANCE

Ice Painting and Painting Accessories	14 - 15
Line Kits	16 - 17
Ice and Snow Traction Aids	18
Board and Shielding Cleaning Products	18 - 19
Hoses and Hose Accessories	20
Shovels, Scrapers, Squeegees and Snow Pushers	21
Ice Edgers and Ice Resurfacer Parts	22 - 23

FACILITY PRODUCTS

Protective Netting	24
Flooring	25 - 27
Benches and Bench Supports	28
Locker Room Products	29
Rental Skates	30
Skate Sharpeners	31
Dehumidifiers	32
Scoreboards	32

CONVERSION

ArenaDeck® Ice Covers	33
Ice Dams and Poly Ramps	34
Drapes and Tunnel Covers	35
Retractable Netting	35
Protective Floor Runners	35
Glass Lifters	36
Storage Carts	37 - 38

SKILLS DEVELOPMENT

Cross-Ice Rink Dividers and Pads	39 - 40
Cross-Ice Goal Packages	41
Performance Aids	41 - 42
Broomball Products	43
Coaching Aids	44

DASHBOARD REPLACEMENTS COMPONENTS

Advertising Panels and Hardware	45 - 46
Dashboard Cladding, Kick Plate, Caprail	47 - 48
Ice Line Kits	48 - 49
Threshold, Brackets, SoftCap®	49
Outdoor Dashboard Components	50
Glass and Acrylic Shielding	51
Shielding Supports, Sleeves, Hardware	52 - 55
Gaskets and Acrylic Clips	56 - 57
Curved Acrylic Replacement	58
Corner Pads	58 - 59
Gate Hardware	60 - 64
Screws and Fasteners	65

ARENA EXTRAS

Gates, Panels, Residential Rinks, Spectator Railing	66
-----------------------------------------------------	----

SERVICE SCHEDULES

It makes good sense, and we can help!

Remember, dasher boards are not a static device. Gates are opened and shut (sometimes slammed) hundreds of times a month; bolts and nuts can loosen; shielding can get chipped and marked up; gates can get out of plumb. And yes, sometimes the guy driving the resurfacer might just give the boards a 'bit of a rub'.

Your dasher boards are one of the most visible and memorable parts of your rink. People take away lasting impressions about the kind of facility you operate in part based on what it looks like, and if your boards look bad - if they look like you don't look after them - then that may end up hurting your reputation and your potential repeat business.

More importantly than that, dasher boards need to be maintained to ensure they operate in a manner that assures the safety of the skaters and hockey players who use it.

Maintaining your boards costs a whole lot less than replacing them, so to help you keep them working properly, and lasting a long time, contact us to arrange a service call appointment. Our dasher board technicians and installation supervisors are seasoned, experienced and ready to help you keep your boards looking and working their best all year round. Call today for a no-obligation quote.

And don't forget, we also carry everything you need to keep outdoor rinks in great shape too! Whatever you need, we've got it. From replacement fencing, to fence posts, and all the necessary hardware. Call us for more details.

See below for a recommended maintenance schedule, for more detailed information, consult resources such as ORFA's Guidelines for Arena Dasher Board and Shielding Systems, which you can access from our website: athletica.com

Dasherboard Panels	WEEKLY	MONTHLY	SEASONAL
Check torque of floor anchors, re-tighten as required		●	●
Visually inspect plumb of dasher wall, replumb as required		●	●
Visually inspect framing for deformation or cracks, repair or replace as required		●	●
Check attachment of polyethylene facing, kickplate and caprail to framing, re-adjust/tighten as required	●		●
Inspect panel joints (ice side) for facing alignment, re-adjust/tighten as required		●	●
Check torque of panel connection bolts, re-tighten as required		●	●
Cleaning of polyethylene facing/kickplate		●	●

Gates	WEEKLY	MONTHLY	SEASONAL
Inspect gate swing for proper clearance, adjust as required	●		●
Inspect any steel hardware for start of corrosion. Clean off rust and spray galvanize as required		●	
Inspect gate latches for proper operation, adjust as required	●		
Inspect door/panel frame facing alignment (surface side)	●		
Lubricate gate hinges		●	●
Lubricate adjustable caster		●	●
Check torque of hardware fasteners, re-tighten as required		●	●
Inspect threshold covers for wear and attachment, replace and refasten as required		●	●

Shielding and Supports	WEEKLY	MONTHLY	SEASONAL
Visual inspection of shielding for chips and cracks	●	●	●
Visual inspection of shielding for proper engagement in its support system, tighten and reposition as required		●	●
Visual inspection for proper seating of shielding support base		●	●
Visual inspection of the secure fastening and physical condition of termination pads	●		



Have our team service your arena.

GOAL PACKAGES

GOAL PACKAGES



Crystaplex® goal frames are used by the NHL, AHL, and IIHF and meet all dimensional standards. Buy the best for your arena. *Sold in pairs.*

Crystaplex® 400 Competitive Package

- 40" red and white goal frames
- 6 mm knotless resin nets
- Bottom pads
- Vertical/back pads
- Nylon Net protectors/skirts
- Upper net tie bar

Game Ready
Unstrung

#102200
#102201



NHL approved net tie bar.

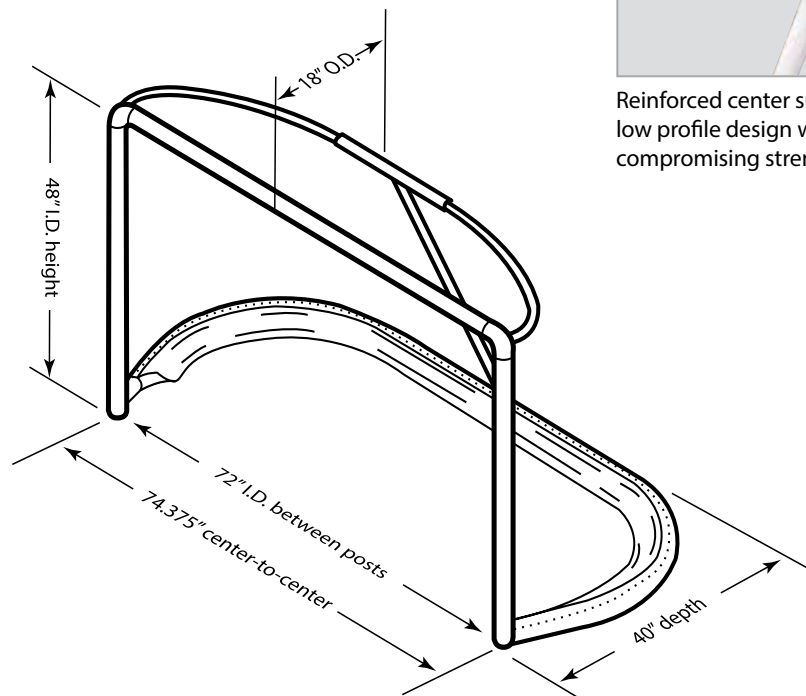

Reinforced center support allows low profile design without compromising strength.

GOAL PACKAGES

Made of heavy duty tubular steel with rounded corners, these durable frames conform to standards and safety rules at all game levels. Lacing twine included. *Sold in pairs.*

Pro Series™ 400 Package

- 40" red goal frames
- 6 mm knotless resin nets
- Bottom pads
- Vertical/back pads
- Net protectors/skirts

Game Ready

#103558

Unstrung

#103559

Pro Series™ 440 Package

- 44" red goal frames
- 6 mm knotless resin nets
- Bottom pads
- Vertical/back pads
- Net protectors/skirts

Game Ready

#102157

Unstrung

#102158

Recreation 400 Package

- 40" red goal frames
- 6 mm knotless nylon nets
- Bottom pads
- Vertical/back pads
- Net protectors/skirts

Game Ready

#103556

Unstrung

#103557

Recreation 440 Package

- 44" red goal frames
- 6 mm knotless nylon nets
- Bottom pads
- Vertical/back pads
- Net protectors/skirts

Game Ready

#101793

Unstrung

#102156



Game Ready package includes stringing with netting, pads and net protectors/skirts. All you have to do is drop on the ice.

Becker 400 Package

- 40" red and white goal frames
- 6 mm knotless resin nets
- Bottom pads
- Vertical/back pads
- Net protectors/skirts

Game Ready

#40.55116.1

Unstrung

#40.55116

Becker 440 Package

- 44" red goal frames
- 6 mm knotless resin nets
- Bottom pads
- Vertical/back pads
- Net protectors/skirts

Game Ready

#40.55110.1

Unstrung

#40.55110

Becker 445 Package

- 44" red goal frames
- 5 mm knotless resin nets
- Bottom pads
- Vertical/back pads
- Net protectors/skirts

Game Ready

#40.55090.1

Unstrung

#40.55090

GOAL ACCESSORIES

Net/Pad Package for 44" Frame

- 6 mm knotless nets
- Nylon net protectors
- Bottom pads
- Vertical/back pads
- Lacing twine

Net/Pad Package with Athletica Nylon Nets	#100231
Net/Pad Package with Athletica Resin Coated Nets	#100230
Net/Pad Package with Becker Resin Coated Nets	#40.55351

Net/Pad Package for 40" Frame

- 6 mm knotless nets
- Nylon net protectors
- Bottom pads
- Vertical/back pads
- Lacing twine

Net/Pad Package with Athletica Nylon Nets	#103437
Net/Pad Package with Athletica Resin Coated Nets	#102565
Net/Pad Package with Becker Resin Coated Nets	#40.55352

Net/Pad Package for 34" Frame

- 6 mm knotless nets
- Nylon net protectors
- Bottom pads
- Vertical/back pads
- Lacing twine

Net/Pad Package with Athletica Nylon Nets	#100232
Net/Pad Package with Athletica Resin Coated Nets	#100233

5 mm Net/Pad Package for 44" Frame

- 5 mm woven nylon nets
- Net protectors/skirts
- Bottom pads
- Vertical/back pads
- Lacing twine
- Substitutions available to fit 40" frame

5 mm Net/Pad package for 44" frame	#40.55331
-------------------------------------------	------------------

Pad Kits Only for 44" Frame

- Bottom pads
- Vertical/back pads
- Top pads
- Top center pads

Pad Kit for 44" frame	#40.55400
------------------------------	------------------



GOAL ACCESSORIES



Regulation Goal Nets

One-piece construction. Fits standard goal frames of 4'H x 6'W. Designed for high use environments. Lacing twine included. *Sold in pairs.*

6mm Athletica Knotless Nylon	40"/44" frame	#102275
6mm Athletica Resin Coated	40"/44" frame	#102277
6mm Becker Resin Coated	40"/44" frame	#40.10260
6mm Athletica Knotless Nylon	34" frame	#101314
6mm Athletica Resin Coated	34" frame	#101320
5mm Becker Knotless Nylon	34"/40"/44" frame	#40.10270



Goal Frames

Durable tubular steel with rounded corners. Conforms to standards and safety rules of all game levels.

Crystaplex Red/White	44"	#100235
Becker Red	44"	#40.10160
Crystaplex Red/White	40"	#101991
Becker Red/White	40"	#40.10165
Crystaplex Red	34"	#102236



Goal Frame Pads

Heavy duty white tear-resistant nylon covering fits regulation size goal frames. *Sold in pairs.*

BOTTOM PADS - Grommets for lace attachment.

34" frame	#101393
40" frame	#102282
44" frame	#102286

TOP PADS

Standard - With Velcro® attachment	#102285
Premium - Grommets for lace attachment	#103578

TOP/CENTER PADS

Standard - With Velcro® attachment	#102289
Premium - Grommets for lace attachment	#103579

VERTICAL/BACK PADS - Velcro® attachment.

Reduced diameter	#102281
-------------------------	----------------

GOAL ACCESSORIES

Vinyl Net Protectors

Fits regulation size goal frames with grommets every 4" on center. Lacing twine included. *Sold in pairs.*

Vinyl skirt	44"	#40.10315
Vinyl skirt	40"	#40.10316

Nylon Net Protectors

Extend the life of nets by minimizing skate cuts. Lacing twine included. *Sold in pairs.*

Nylon skirt	44"	#102278
Nylon skirt	40"	#102283
Nylon skirt	34"	#103577

Pro-style Net Protectors

Special dual layer construction. Base layer is reinforced webbing with grommets and a second layer is 35 oz vinyl; stitched together to create a one-piece net protector. Top layer enhances net appearance and protects lacing from skate damage. Skirt is pleated for an improved fit around the goal radius. Lacing twine included. *Sold in pairs.*

Pro-style	44"	#102284
Pro-style	40"	#102515

Clear Net Protectors

Similar in design to the Pro-Style. Allows for easy visibility. Detachable clear end protectors come with extra set of ends. Lacing twine included. *Sold in pairs.*

Clear end	44"	#40.10327
Clear end (detachable)	40"	#102585
Clear end	40"	#40.10326
White bottom, clear top vinyl	40"	#50.10355

Nylon Lacing and Repair Twine

Multi-use braided nylon twine.

4 mm x 220' roll (450 lb break strength)	#40.10240
4 mm x 330' roll (550 lb break strength)	#102584

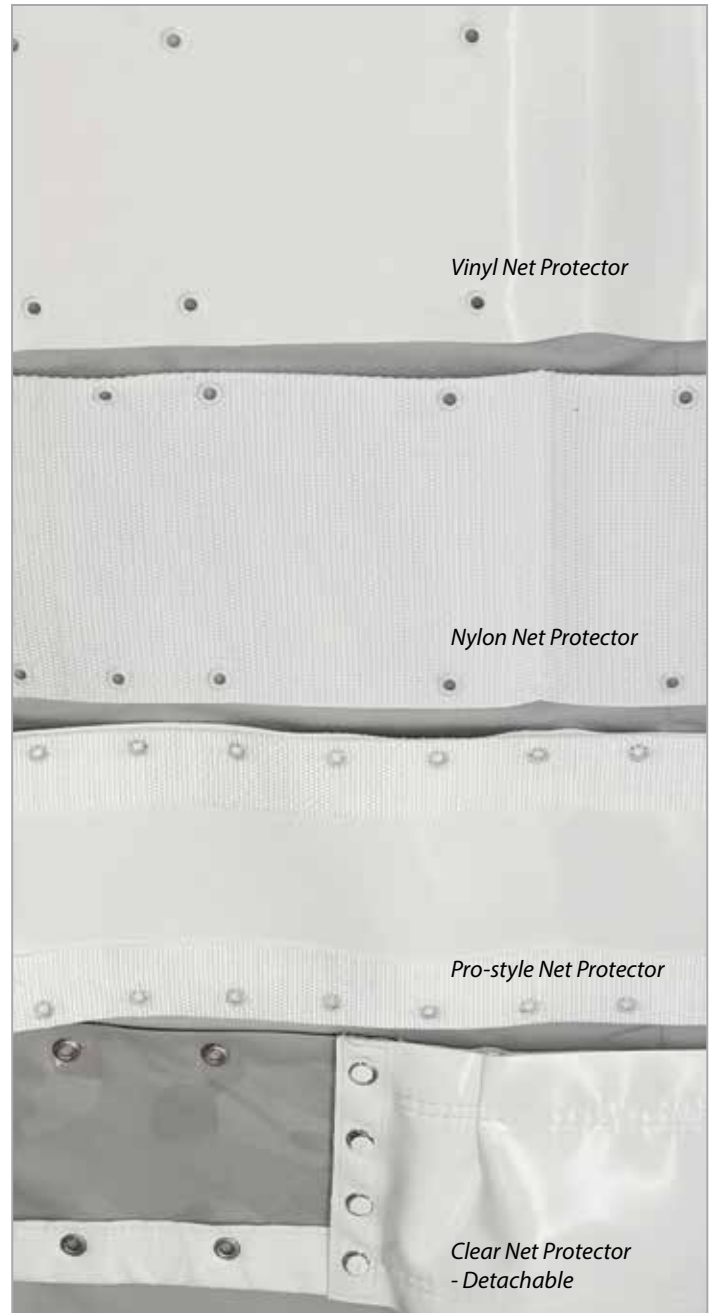

Vinyl Net Protector

Nylon Net Protector

Pro-style Net Protector

Clear Net Protector - Detachable



Photo courtesy of Bowling Green State University.

Custom Embroidery

Customize your net protectors with your logo, brand or tagline. Great to use as revenue generating premium sponsorship opportunity. Call for information and pricing.

GOAL ACCESSORIES

Goal Frame Transporter

Easily transport your goal frames on and off the ice. Fits all regulation size 6' wide frames. Choose from traditional with extra handle caster or collapsible for easy storage with 360° turning caster wheels. Fits all regulation size 6' wide and other size frames. *Sold individually.*

Traditional goal dolly #103730

Blue collapsible goal dolly #101808



Edge Protech

Protects skate blades from damaging goal post strikes during play. Snap-on design. Made by goalies for goalies. *Sold in pairs.*

Edge Protech #101295



Water Bottle Holder

Constructed out of lightweight and durable material with Velcro® strips for easy attachment to back of goal frame. Choose from solid colors with Athletica tag, white with Becker logo, or custom branded option. *Sold individually.*

Blue with Athletica tag #102898

Red with Athletica tag #102892

White with Athletica tag #103422

Custom logo (artwork needed) #40.10332



GOAL ACCESSORIES

Marsh Pegs

The professionals choice! Reduce injuries - Marsh pegs allow the goal frame to release on hard impact. Reduce game delays - No more unintentional net dislodging. Standard pegs 8" long. AHL/NCAA pegs 10" long. *Sold in set of 4.*

Red	1 3/16" dia.	#101309
Teal green	1 5/8" dia.	#101312
Blue	1 3/8" dia.	#101310
Lime green (AHL/NCAA Size)	1 7/8" dia.	#101311
Marsh Peg insert Kit		#102126



Wylie Posts

A revolutionary product for hockey that replaces the solid steel pegs currently used to anchor nets. *Sold in pairs.*

Wylie Posts #40.10560



Piranha Pegs

Built to last, with 1/4" steel plate and 3/4" stainless steel pegs. Contains hardened styrenebutadiene rubber for high durability and a tapered top for quick loading. *Sold in pairs.*

Piranha Pegs #103521



Freeze-In Posts

Helps minimize injuries by breaking away from ice on impact. Zinc plated steel construction. *Sold in set of 4.*

- 1 1/2" dia. for professional style goal frame** #40.10550
- 1 3/8" dia. for practice frames** #40.10540
- 3/4" dia. for broomball frames** #40.10530



GOAL ACCESSORIES

Practice Goal Frame Packages

Save on wear and tear of your game goal frames with these light-weight practice goals. *Sold in pairs.*

4' H x 6' W x 24" D frame	5 mm	#40.55130
4' H x 6' W x 34" D frame	6 mm	#103779

Practice Goal Frame

Sold in pairs.

4' H x 6' W x 24" D	Red goal frame	#40.10140
4' H x 6' W x 34" D	Red goal frame	#102236

Practice Goal Netting

Made of woven knotless nylon, available in 4'H x 6'W. *Sold in pairs.*

Nylon practice goal net - White	5 mm	#40.10270
----------------------------------------	-------------	------------------



Cross-Ice Goal Frame Packages

Used for cross-ice. Net and skirt included. Constructed of tubular steel with rounded corners. *Sold in pairs.*

JUNIOR GOAL FRAME PACKAGE - 3' H x 4' W x 26" D

Collapsible	#103357
Welded - Unstrung	#102836
Welded - Prestrung	#103555

MINI-MITE GOAL FRAME PACKAGE - 2' H x 3' W x 14" D

Collapsible	#101443
Welded - Unstrung	#102717
Welded - Prestrung	#103554



RINK MAINTENANCE

JET ICE PAINT

Jet Ice Super White Powder 3000

High quality white powder ice paint specially formulated to provide a brilliant white ice surface. Superior coverage and easy installation. Coverage requires 3 coats. 85' x 200' - 8 boxes, 100' x 200' - 10 boxes. Each box weighs 45 lbs. (20 kg).

Super White 3000 **45 lb (20 kg) box** **#101600**



Jet Ice Liquid Ice Paint

Jet Ice's liquid ice paints are stocked in 3 standard colors. Custom colors are available. A standard rink requires 1 pail of each color. Sold in 1 gallon pails.

Jet Ice Red	1 gal	#101599
Jet Ice Blue	1 gal	#101596
Jet Ice Black	1 gal	#101859
Jet Ice Goal Crease Blue	1 gal	#101597
Jet Ice Logo White	1 gal	#103742
Jet Ice Custom Color	1 gal	#101598



LUMIN'ICE PAINT - Available only in the U.S.

Lumin'Ice Premium Paint

No additive needed for this top-of-the-line powder ice paint. 85' x 200' - 9 bags

Lumin'Ice Premium White **50 lb bag** **#62.90100**

Lumin'Ice Basic Paint

Basic white powder paint provides excellent coverage at a reasonable price. 85' x 200' - 15 bags

Lumin'Ice Basic White **50 lb bag** **#62.90110**



Lumin'Ice Liquid Line and Logo Paint

Excellent spreading characteristics reducing the amount of paint consumption. Sold in one gallon containers.

Lumin'Ice Blue	1 gal	#62.90120
Lumin'Ice Goal Crease Blue	1 gal	#62.90130
Lumin'Ice Red	1 gal	#62.90140
Lumin'Ice Black	1 gal	#62.90150
Lumin'Ice Yellow	1 gal	#62.90160
Lumin'Ice Green	1 gal	#62.90170
Lumin'Ice Custom Color	1 gal	#62.90180



RINK MAINTENANCE

Bright Seal Concrete Paint

An alternative to painting ice, Bright Seal Concrete Paint is oil-based and long-wearing. 1 gallon covers approximately 200 sq ft for the first coat and 300 sq ft for the second coat. Indicate if in VOC regulated state: CT, DE, MA, MD, ME, NJ, NH, NY, PA, RI, VA, VT



White	1 gal	#62.10140
White	5 gal	#62.10160
White	55 gal	#62.10170
Clear	55 gal	#62.10030
Blue	1 gal	#62.10110
Red	1 gal	#62.10130
Goal Crease	1 gal	#62.10180
Custom Logo	1 gal	#62.10120

Jet Ice Line Marking Products

Ice marking and template kit "Developed by ice makers for ice makers". These kits include everything you need to lay out your floors including brushes, all templates, cables, thread and markers. Just add the white and you're all set! Available for IIHF, NCAA, and NHL game line configurations.

IIHF	#102948
NCAA/USA Hockey	#102950
Hockey Canada	#102949
NHL	#101308

Ice Painting Systems

All you need for easy application. Includes 5.5 HP pump with motor, mixer, 125 gal mixing tank, 10' spray boom. Also available in mobile system with cart, hose reel, and 250' of 3/4" hose with flooding nozzle.

Painting System (No Cart)

#62.10480

Mobile Painting System with Cart

#62.10480.2



PAINTING SYSTEMS AND TOOLS

Jet Ice Paint Stick

Light-weight with the flexibility to adjust the liquid paint flow. Allows you to accurately apply lines and circles on the ice surface with 2" paint head.

Jet Ice Paint Stick

#101405



Spray Boom

Constructed of high quality materials and threaded hose connections for top performance. "T-Jet" nozzles provide you with a consistent and uniform 10' wide spray pattern.

Spray Boom

#62.10440

Replacement Spray Boom Nozzles

#62.10460



Pounce Pattern

The best tool to use if you choose to paint your own logos. Simply lay paper on the ice and use a chalk pad to pounce the pattern through the holes on to the ice, then remove the paper and paint in the outlines.

#62.10420

RINK MAINTENANCE



Ultimate Vinyl Line Kits

These reusable vinyl hockey line kits have everything you need for a quicker, easier install. Second sheet kits do not include utility kit.

COMPLETE KITS	BASIC KITS	UTILITY KITS
1 Roll 12" Red Line	1 Roll 12" Red Line	One Rink Diagram
2 Rolls 12" Blue Line	2 Rolls 12" Blue Line	6' 1" Steel Wire Cable (for Goal Crease)
4 Rolls 2" Red Line	4 Rolls 2" Red Line	10' Steel Wire Cable (For Referee Crease)
8 Each 24" Red Dots with Die Cut	8 Each 24" Red Dots with Die Cut	15' Steel Wire Cable (For Face Off Circles)
1 Each 12" Blue Dot	1 Each 12" Blue Dot	2 Markers
1 Each Blue 15' Circle	1 Each Blue 15' Circle	1 Each 250' Roll of String
4 Each Red 15' Circles	4 Each Red 15' Circles	
1 Each Referee Crease	1 Each Referee Crease	
2 Each Goal Creases		
1 Each Utility Pack		
2 Rolls 2" Red Checkered Line		
1 Each 2-Piece Rubber Template Kit		
Rink Layout Diagram		
1 Each Utility Pack		
Installation Instructions		

Ultimate Vinyl Line Kits

Complete Line Kit	200' x 85'	#92.55470
Complete Line Kit	200' x 100'	#92.55450
Complete Line Kit for Second Sheet	200' x 85'	#92.55460
Complete Line Kit for Second Sheet	200' x 100'	#92.55440
Basic Line Kit	200' x 85'	#92.22500
Basic Line Kit	200' x 100'	#92.22480
Utility Rink Kit	200' x 85'	#92.22520

Ultimate Vinyl Individual Components

1 Roll 12" Red Line	200' x 85' Rink	#92.10320
4 Rolls 2" Red Line	200' x 85' Rink	#92.10350
2 Rolls 12" Blue Line	200' x 85' Rink	#92.10290
1 Roll 12" Red Line	200' x 100' Rink	#92.10310
4 Rolls 2" Red Line	200' x 100' Rink	#92.10340
2 Rolls 12" Blue Line	200' x 100' Rink	#92.10300
1 Each Blue Dot		#92.10130
4 Each Red 15' Circles		#92.10070
8 Each 24" Red Dots w/ Die Cut		#92.10140
1 Each Blue 15' Circles		#92.10060
1 Each Referee Crease		#92.10410
2 Each Goal Crease		
- NHL, NCAA, NFHS Format		#92.10170
2 Each Goal Crease Red Outer Radius		#92.10160
1 Each 2-Piece Rubber Template Kit		#62.10470

Ultimate Vinyl In-Ice Graphics

Achieve a perfect result every time with custom in-ice vinyl logos.

Sold by the square foot.

Ultimate Vinyl In-Ice Graphics	#42.10170
--------------------------------	-----------

RINK MAINTENANCE

Reusable Goal Crease Kits

Reusable goal crease kit is easy to install. Simply lay out on the ice and freeze in. Store dry and use the same crease year after year.
Sold in pairs.

Ultimate Vinyl Goal Crease	NHL, NCAA, NFHS Format	#92.10170
Ultimate Vinyl Goal Crease	USA Hockey Format	#92.10155
Ultimate Vinyl Goal Crease	IIHF Format	#92.10230
Textile Goal Crease	NHL Format	#102959
Textile Goal Crease	USA Hockey Format	#102878

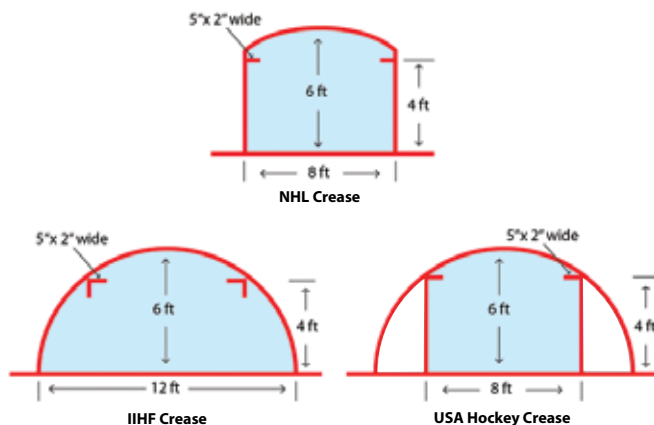

Ultimate Vinyl Curling Kit

Purchase kit or components to transform your ice quickly and easily.
Sold in pairs (two houses).

Blue Outer Ring Curling Kit	#92.10110
Red Outer Rink Curling Kit	#92.10120
4" x 50' Black Hog Line	#92.10080
1" Black Curling Ribbon	#66.10195
3/4" Black Curling Ribbon	#66.10190



Ultimate Vinyl White Base Coat

Reusable white base coat alternative, great for outdoor and studio rinks. Sold in three roll sizes - 5' x 90', 5' x 180', and 5' x 205'.

Ultimate Vinyl White Base Coat	#92.10550
---------------------------------------	------------------



Single-Use Kits

Made with biodegradable material. The Crystalline and Becker kits contain enough material for two single applications.

Crystalline Line Kit	#101293	
Becker Line Kit	#66.10180	
Crystalline Goal Crease Kits	NHL	#101305
	NCAA	#101806
	USA Hockey	#101807
Becker Goal Crease Kits	#66.10185	
Becker Paper Letters	#66.10140	

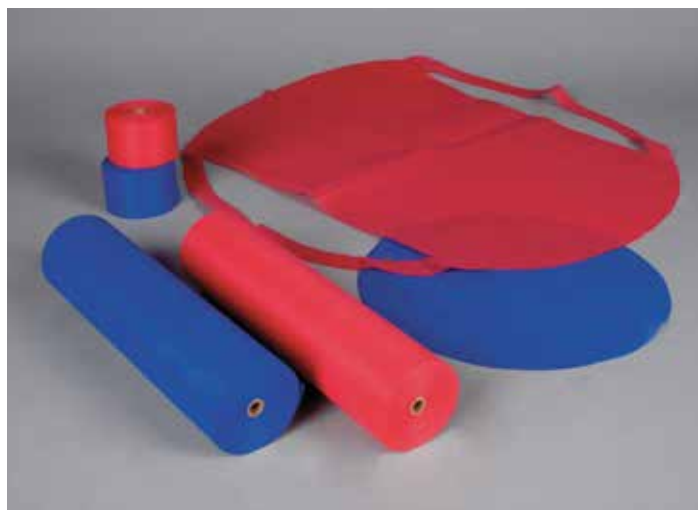

RINK MAINTENANCE

Ice and Snow Traction Aids - Athletica

Lightweight solution, with 360° spike pattern that provides more push and lateral grip. Carbide spikes are integrated into the open/close split rubber tread for improved traction.

Small / Medium #103513
Large / Extra Large #103514

Ice and Snow Traction Aids - Becker

Easy-to-attach safety soles provide traction on ice. Made from lightweight, flexible material.

Small Size 4 - 7 #32.10300.0
Medium Size 7 ½ - 10 #32.10300.1
Large Size 10 ½ - 13 #32.10300.2
X-Large Size 13 ½ - 16 #32.10300.3



Athletica Traction Aid

Becker Traction Aid

BOARD CLEANING PRODUCTS

Restoration Kit

Kit includes high speed polisher, backing plate, 2 black polishing pads, cleaning brush, 2 micro-fiber towels and squirt bottle. Cleaning polish sold separately.

Restoration Kit #101290
High Speed Polisher #101288
Backing Plate #101281
Polishing Pad - Black #101800
Cleaning Brush #101285
Micro-fiber Towels #101291
Squirt Bottle #101282



Cyclo Polisher

Kit includes polishing machine, 2 backing plates, 2 grit cleaning pads, 4 green foam disks (Velcro) and 2 wool pile pads.

Cyclo Polishing Kit #30.55145
Cyclo Polishing Machine Only #30.10055
Backing Plate Holder #30.10513
Grit Cleaning Pad #30.10110
Green Foam Disk #30.10090
Wool Pile Pad #30.10080
Scrub Brush #30.10120



Rink Erasers

Remove puck, tape, and scuff marks with only plain water and some light scrubbing. Suitable for tempered glass, aluminum supports, dasher poly, ad panels, painted locker room walls, fiberglass wall boards and much more. No rubber gloves or protective eyewear required.

Rink Erasers
- Case of 100 4" x 4" x 1" pads #101410



RINK MAINTENANCE

Clear D Zone Citrus Board Cleaner

Highly effective, concentrated ECO friendly cleaner is 100% biodegradable and contains no solvents, caustics or toxins. Use full strength or dilute to increase coverage.

Clear D Zone Citrus Board Cleaner
- 1 gal bottle #101286



Puck-Off Dasher Board Puck Mark Remover

A multi-purpose solution for use on dasher boards to remove stubborn puck marks. Sold in case of 12 one liter bottles.

Puck-Off #30.10171



Blue Dash

A highly abrasive dasher board cleaner for those really tough jobs.

Blue Dash 1 gal bottle #30.10010

Citrusolve

A general purpose cleaner for boards and all around the arena.

Citrusolve 1 gal bottle #30.10020

Exceed Board Sealer

Apply to dasher board facing to seal and make future cleaning easier. Apply two light coats to new boards or immediately after cleaning existing boards.

Exceed Board Sealer 1 gal bottle #30.10150

GLASS CLEANING PRODUCTS

Clear D Zone Rink Glass Polish

Optimized for use with Crystaplex® Acrylic Shielding. This one step cleaner is safe to use on tempered glass, acrylic and polycarbonate. Outstanding results are achieved with the combination of heat/friction and the cleaner. Simple, fast, and economical. 3 gallons are required for a full size NHL rink.



Clear D Zone Polish
- 1 gal bottle #101287

Clear D Zone Polish
- 12 oz. Sample bottle #101280

Glass Wash Kit

For light duty cleaning between events. Includes large eraser pad, swivel pad holder, extension handle, water blade squeegee and soap.

- Glass Wash Kit** #102990
- Extension Handle** #102989
- Swivel Pad Holder** #102935
- Glasswash Soap - 32 oz.** #102547
- Water Blade Squeegee** #101294
- Large Eraser Pad** #102934



Novus #1

Gently cleans without scratching. Leaves a shine that resist fogging, repels dust, and eliminates static.

Novus #1 1/2 gal bottle #30.10180

Novus #2

Removes fine scratches, haziness and abrasions.

Novus #2 1/2 gal bottle #30.10190

Novus #3

Removes heavy scratches and abrasions.

Novus #3 1/2 gal bottle #30.10210



RINK MAINTENANCE

HOSES AND HOSE ACCESSORIES

Hoses

Commercial-grade rubber hose. Made to order in required length (in feet), diameter and fittings. Service temperature rating: -20° F to 190° F

ATHLETICA HOSES

1" Standard	Black	#105323
1" Non-Marking	Red	#103696

BECKER HOSES

3/4"	Red	#50.10066
3/4"	Blue	#50.10067
3/4"	Yellow	#50.10068
3/4"	Grey	#50.10069
1"	Red	#50.10020
1"	Black	#50.10010
1.5"	Black	#50.10030
1.5"	Red	#50.10040



Flooding Nozzles

Spray fine or heavy with our adjustable brass or plastic nozzles.

Brass 1"	#105322
Lexan .75"	#50.10110
Lexan 1"	#50.10130
Lexan 1.5"	#50.10150



Fittings

Fitting for 3/4" Hose	#50.10070
Fitting for 1" Hose	#50.10100
Fitting for 1.5" Hose	#50.10080

Instant Ice Slush Repair

When mixed with water, Instant Slush Ice Repair creates an ice-like surface to seal gaps and repair cracks and divots in your ice. One scoop makes a 5 gallon bucket.

Instant Slush Ice Repair	
1 gal bucket	#50.10210

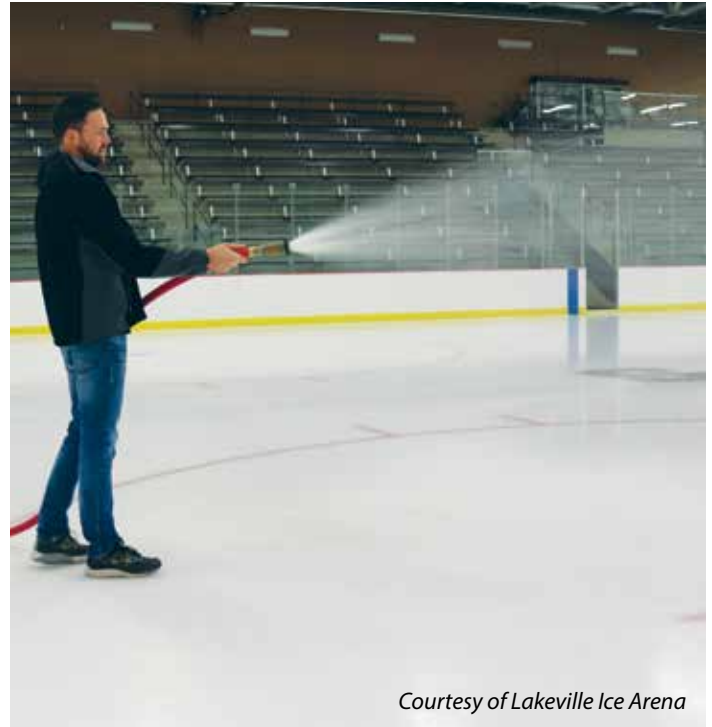

Courtesy of Lakeville Ice Arena

Hose Reels

Steel construction, powder coated. Reels have self-aligning bearings, locking mechanisms, tension brake and swivel joint for water connection. Sized to fit your needs and available in manual or powered rewind.

Specify the following when requesting a quote: Wall or floor mount. Manual or power rewind. Length and diameter of hose to be stored.



Hose Reel - Crank Wind

Durable metal reel keeps your hose neat and accessible.

Holds 250' of 1" Hose	#50.10175
Holds 275' of 3/4" Hose	#50.10176



RINK MAINTENANCE

SHOVELS, SCRAPERS, SQUEEGEES, AND SNOW PUSHERS

Plastic Shovel

Heavy-duty, industrial grade.

Dominator Plastic Scoop Shovel #102267

Dominator Plastic Scoop Shovel



Aluminum Scoop Shovel

Aluminum Scoop Shovel

Durable, lightweight aluminum scoop comes with 30" handle and 15-1/4" x 19" blade.

Aluminum Scoop Shovel #102262

General Purpose Shovel

This durable shovel features a 14 1/2" x 15 1/2" carbon steel blade and 38" flame-toughened ash handle.

Snow Shovel #84.10090

General Purpose Shovel



Scraper

Reduce ice build up at gate entrances and keep your ice in top shape.

7" x 6" Blade #100674

Scraper

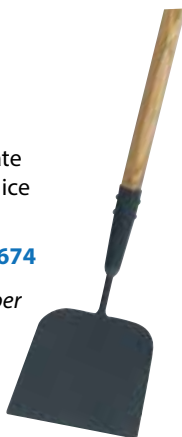

Hot-Forged Scraper

Durable forged steel ice scraper has 8" x 5" blade and tough 54" ash handle or straight 48" steel handle.

Ash Handle Scraper #84.10040

Steel Handle Scraper #84.10030

Hot-forged Scraper



Curved Squeegee

Quickly remove excess water off your ice surface. 36" straight with curved end and wood handle.

Squeegee #103438

Replacement Wood Handle #101420

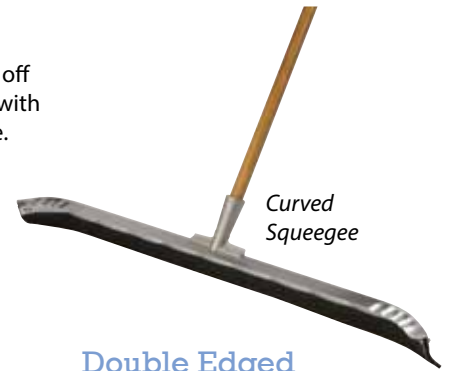

Curved Squeegee

Double Edged Squeegee

Double edged 36" straight squeegee.

Squeegee, Handle and Brace #84.55235

Squeegee Only #84.10165

Handle Only #84.10176

Brace Only #84.10155

Double-edged Squeegee

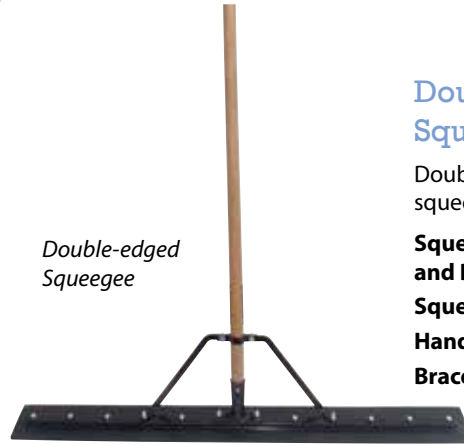

Snow Pushers

Industrial strength snow pusher that works great on a wide variety of surfaces including ice, concrete, rubber, asphalt and wood.

Snowplow Pusher - 24" Width #84.10093

Snowplow Pusher - 30" Width #84.10094

Snowplow Pusher - 36" Width #101413

Snowplow Pusher - 48" Width #101414

Snowplow Pusher



Heavy-Duty Steel Pusher

Features carbon steel blade with 48" handle made of durable ash.

Steel Pusher - 24" Length #84.10060

Steel Pusher - 30" Length #84.10070

Steel Pusher



RINK MAINTENANCE

ICE EDGERS

Zamboni Gas Power Edger

Powerful 10.5 HP engine and long lasting eight-sided 18" cutters reduce replacement time and cost. Designed for maximum ease of operation, the engine and depth controls are located on the handle and the unit provides stable "wander-free" control.

Zamboni Electric Power Edger

The Electric Power Edger brings a corded alternative to facility operators. The powerful electric motor easily handles the unit's 18" cutting path. The heavy-duty steel plate body and runners provide stable control and ease of operation. Another emission-free solution for your arena's edging needs.

Zamboni EZIII Edger

The EZIII electric edger offers a 6.5 HP motor at 36 volts. Its three AGM deep-cycle 12 V batteries were designed to perform for the application. With eight-sided 14" cutters, the EZIII provides an effective, long lasting cut, while saving replacement time and cost.

Olympia Battery Power Edger

Powered by a 9 HP motor, the Olympia Battery Edger is nonpolluting, environmentally friendly, and provides more than 40 minutes of high performance edging between charging. With sealed lead acid gel-filled batteries, eight carbide tipped blades and level controls at your finger tips, the Olympia Battery Edger delivers the finest, pollution free finish in the industry.

Olympia Gas Power Edger

4-cycle 3600 RPM engine with 16" cutters. Ease of use, safety, durability and efficiency are standard features in the Olympia line of hand controlled edgers. Featuring the latest innovations in design, the Olympia Edger line sets a new standard for the industry. From the centralized controls in the handle, to the proven reliability of its engine and cutting mechanism, Olympia Hand Edgers meet all your ice edging needs.

Available in gas or propane.



Edger Cutting Blades

Available for use with several ice edger models.

Square Cutting Blades for Thomsen Edgers

#34.10090

Four Hole Edger Blades

#45.50.51750.4

Two Hole Short Blades

#45.50.51750.5

RINK MAINTENANCE

ICE RESURFACER PARTS

Ice Resurfacer Towels

Made from 100%, 5-ply cotton terry cloth for maximum durability and brass grommets for a superior hold. Available in 77", 80", and 84" lengths.

Terry Ice Resurfacer Towel	77"	#45.30.21177
Terry Ice Resurfacer Towel	80"	#45.30.21160
Terry Ice Resurfacer Towel	84"	#45.30.21161

Felt Resurfacer Towels

Alternative to the terry cotton style. Available in 77", 80" and 84" lengths.

Felt Ice Resurfacer Towel	77"	#45.30.9700
Felt Ice Resurfacer Towel	80"	#45.30.9710
Felt Ice Resurfacer Towel	84"	#45.30.9720



Ice Resurfacer Blades

Tempered steel edge inlaid resurfacer blades that are 5" high x .5" thick with a 27-degree bevel on the knife end. Available in 77", 80", and 84" lengths.

Ice Resurfacer Blade	77"	#45.20.9551
Ice Resurfacer Blade	80"	#45.20.9548
Ice Resurfacer Blade	84"	#45.20.9547

Ice Resurfacer Blade Nuts and Bolts

Both zinc plated and stainless steel nuts and bolts available. Call for brand specific information and pricing.



Board Brush

Available for most ice resurfacers.

Board Brush #45.35.17360



Run-Dry Wash Water Pump Impeller

Available for most ice resurfacers.

Wash Water Pump Impeller with Gasket #45.27.1230

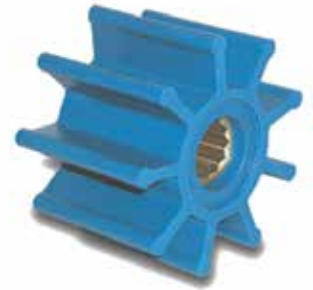

Conditioner Squeegee

Made from a duro-gum rubber, which is resilient yet pliable. 1/4" thick x 84" long - can easily be cut to your size.

Conditioner Squeegee #45.20.21140



Studded Tires

Tires are studded specifically for rink use and are not road worthy. Call for specific brand information.



FACILITY PRODUCTS

PROTECTIVE NETTING

Fan and spectator protective netting is a must in your arenas. Athletica Sport Systems has a depth of experience in this area to help define your needs. From replacement to repair, Athletica's definitive system is everything you need.

Nylon Safety Net

The industry standard for protective netting in hockey rinks. 1-1/2" mesh x 2 mm twine with rope or tape binding edge finish with grommets. Ask about our fire retardant option.

Nylon Safety Net
Nylon Safety Net

Black #101586
White #101587

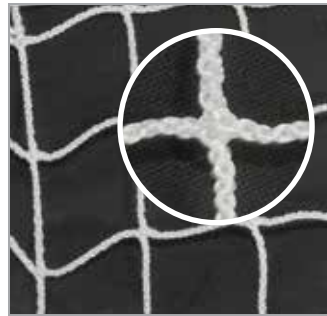

Monofilament Safety Netting

When hung properly, monofilament netting is almost invisible. A metal conduit frame will provide the best results for attaching the net at the ceiling. 3.25" stretch mesh x 1.1 mm twine, diamond pattern with rope binding edge finish only. Order in full foot increments.

Monofilament Safety Netting
Clear #101582

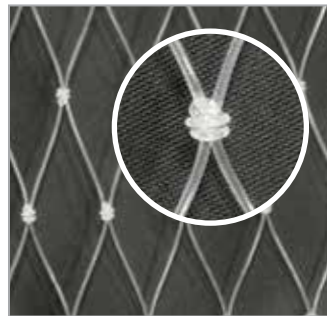

Kevlar® Safety Net

Enjoy superior spectator viewing with a Kevlar® small twine knotted safety net. 3" stretch mesh x 1.2 mm twine with rope binding edge finish. Fire retardant. Custom made to your exact length and height requirements. For indoor use only.

Kevlar® Safety Net
Black #101581

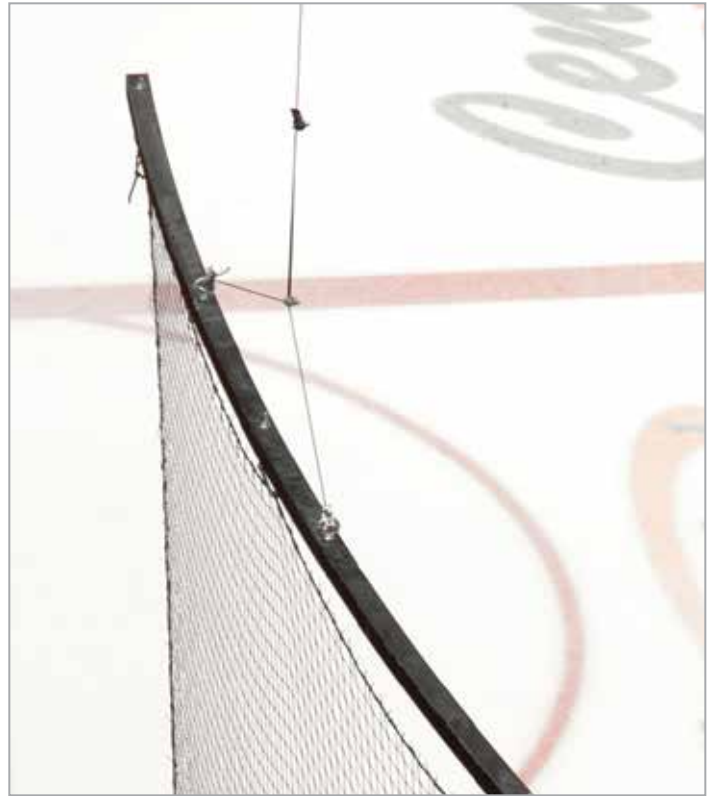
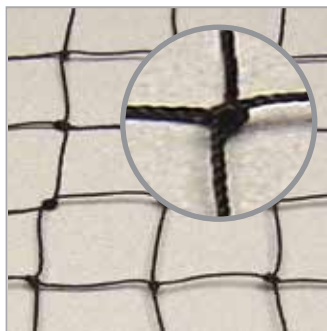

Netting Mounting Hardware

Conduit Frame	Straight (10' sections)	#101273
Conduit Frame	Radius (10' section) - specify radius	#101274
Cables	Galvanized (1.125" x 500' roll)	#101203
Inner Cables	Blackwire (1.1125" x 1000' roll)	#101585
Cable Clamps	Fits 1/8" aircraft cable	#101094
Turnbuckles	4" long	#101082
Beam Clamps	Accepts a 3/8" eyebolt	#100972
Eyebolts	4" turned eyebolt, zinc plated	#101092
Suction Cup	3" to attach netting to glass	#101325
Plastic Zip Ties	Black (8")	#101102
Plastic Zip Ties	White (8")	#101103
Carabiners		#100979
Retractable Tube	1.5" x 17.5"	#102327

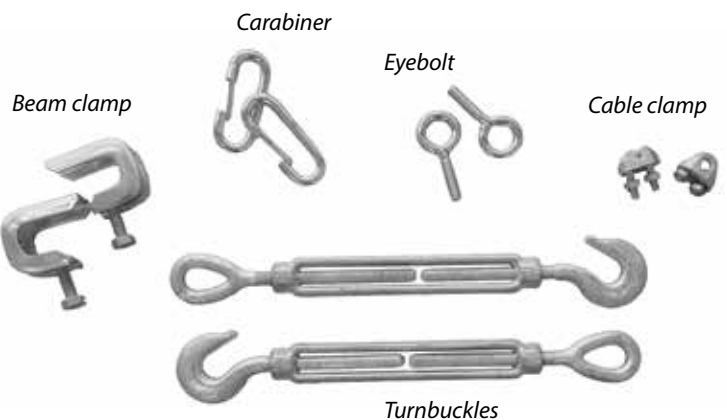

FACILITY PRODUCTS

FLOORING

SportFloor Stamina

Stamina repels liquid to minimize clean up and odor with little maintenance. This makes for a cleaner, longer lasting floor that is designed to withstand heavy use in all types of fitness and arena spaces. Cut and dent resistant. Available in 8mm (5/16"), 10mm (3/8"), 12mm (1/2") 4 x 6 tiles. Stamina Interlocking tiles available.



Stamina

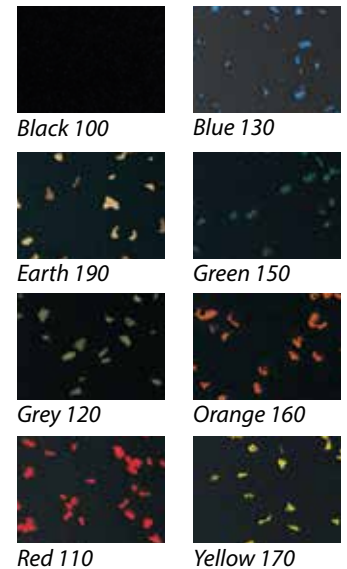

SportFloor ReAction

ReAction provides superior traction for the most demanding athletes and environment. With a non-porous top layer and shock absorption dual-layer system, it is a highly resilient and hygienic floor. Available in 10mm and 8mm tiles and rolls.



ReAction

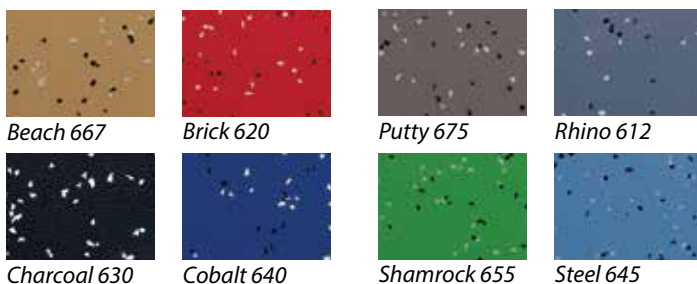

SportFloor ProXL

ProXL is designed to be a long-lasting, high-performance floor. Its versatility, anti-slip, and dual layer durable construction is manufactured to withstand heavy use in the toughest facilities. Available in 10mm and 8mm tiles and rolls.



ProXL

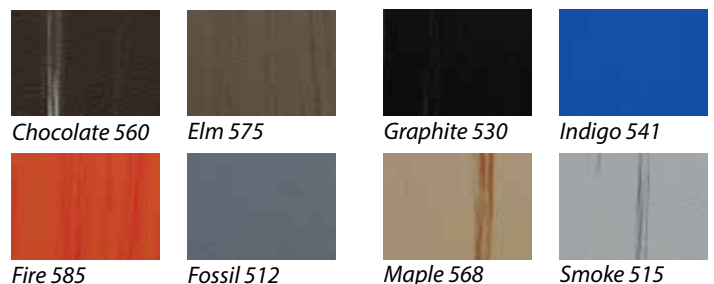

FACILITY PRODUCTS

Mannington Enforcer

Mannington Enforcer is made specifically to resist skate traffic yet looks great in public lobby areas. Enforcer's superior rubber retains color depth, resists indentations and punctures, and is quiet underfoot. Built-in waxes produce natural luster that requires no finishes, top coatings, or waxes. This eliminates stripping, which dramatically lowers maintenance costs.



Regupol

Regupol Aktiv is recommended for all fitness surfaces. It allows for maximum comfort underfoot and absorbs the shock of training impact. Regupol Aktiv Sports and Fitness surface has a five year warranty and is GreenCircle Certified.



Norament 992 Grano

Norament® 992 grano is for sports facilities and fitness centers who operate in a competitive environment where it's important to make a strong impression. The high rubber content makes it the ideal cut-resistant and slip-resistant surface for ice skate blades when skaters are walking or standing around the rink. This flooring is durable, easy to clean and slip-resistant.

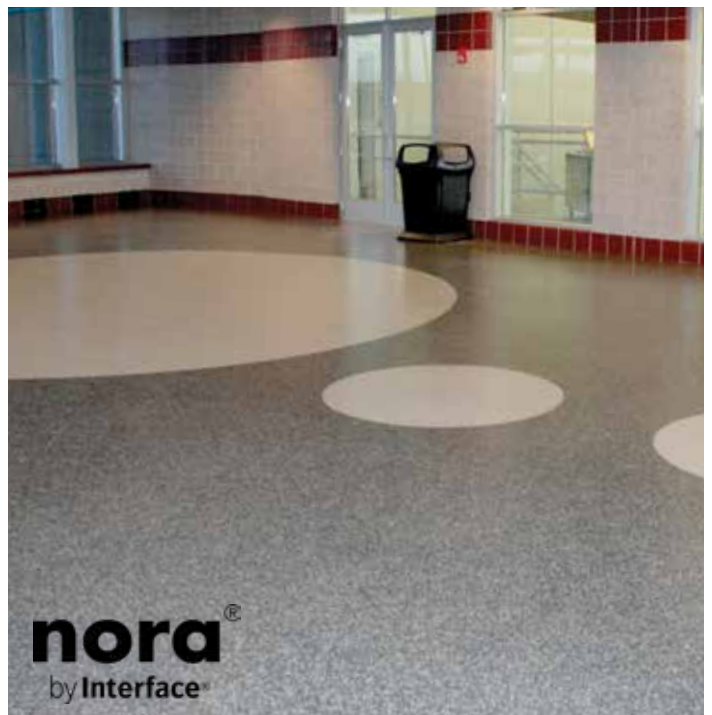

FACILITY PRODUCTS

Ecore Everlast

Everlast is the "original" recycled rubber fitness floor. Designed with punishment in mind using only the finest quality recycled rubber and state-of-the-art technology.



Black Rubber Matting

Recycled black rubber matting is an economical flooring solution that provides excellent skate resistance for years of use. Heavy enough to be "loose laid" or glued in place. Nominal size is 4' x 6' - may need to be squared before installation or can be factory trued to square (47" x 71").

- 3/8" thick Nominal** #102133
- 1/2" thick Nominal** #102047
- 1/2" thick Squared** #101156



Vinyl Runner

Provides durable protection of floors, and pointed ribbing provides maximum traction in walkways. Our vinyl runner is resistant to water and chemical damage, and will not shrink or curl over time. Rubber is more suitable for cold environments.

- Vinyl Runner - 1/8" x 3' x 105'** Black #102407
- Rubber Runner - 3/32" x 3' x 150'** Black #103760

Choice Skate Traffic Carpet

BAP Choice Skate Traffic Carpet is tough enough to survive ice skate traffic yet maintains its natural beauty and luster. Polypropylene fiber lasts longer than traditional nylon carpets and repels moisture to resist rot and mildew. A special anti-microbial treatment results in fast drying.



Rubber Flooring - Roll, Tile, Interlock

Designed as an economical flooring product that combines high skate resistance with budget and aesthetics. We recommend a 3/8" thickness for optimal skate resistance in all three products while our less expensive rolled matting is ideal to reduce seams. Available in black or with EPDM color granules in black or 20% fleck. 16 EPDM color granule options to choose from or reflect your building/team colors with custom color chips at no additional cost. 3 year pro-rated warranty.

- Roll - 3/8" x 4' x 50'** Black #101612
- Roll - 3/8" x 4' x 50'** 20% Fleck #102655

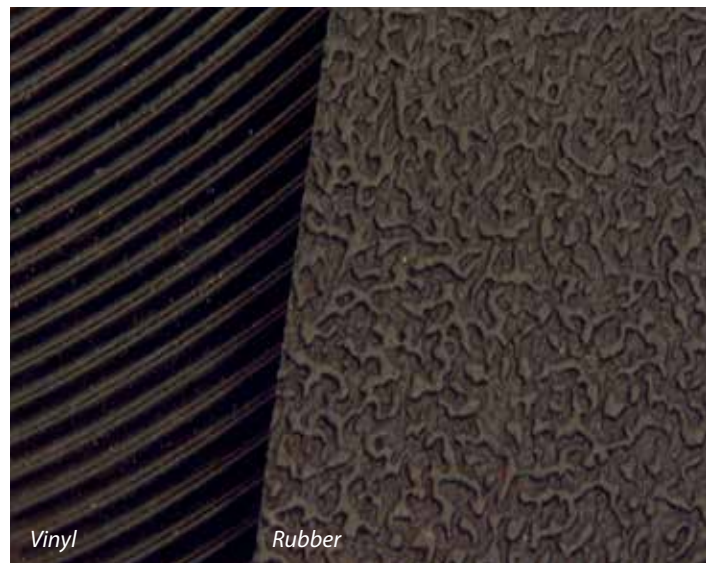

FACILITY PRODUCTS

Aluminum Benches

Aluminum benches are constructed of anodized aluminum plank (1-1/2" D x 9 1/2" W) with a 1/2" poly cover for seating comfort in ice arenas. Aluminum plank provides sufficient strength to provide maximum stiffness with minimum supports. Each bench includes end caps. Stock bench lengths are available in 8' and 24' lengths.

Aluminum Bench	8' Length	#102351
Aluminum Bench	24' Length	#102352

Recycled Plastic Lumber Benches

Recycled plastic lumber benches are comfortable, practical and can stand up to wear and tear. Available in wall mount, floor mount, and mobile cubby designs with 2' x 10" and 2' x 12" plank options. Powder coated brackets are also available.

STANDARD COLORS: Sand, Weathered Wood, Cedar, Light Grey, Tudor Brown, Grey, Light Oak, Turf Green, Off-White, Redwood, and Black.

PREMIUM COLORS are available at additional cost: Bright White, Red, Blue, and Yellow.

NOTE: Plastic lumber is nominally sized as dimensional lumber. Other dimensions are available upon request.



Double Plank Bench - No Back



Double Plank Bench with Back



Bench Supports

Athletica bench supports are aluminum constructed and available in socket, floor mount, and wall mount design. Custom sizes available upon request. Indicated heights are for the support only.

ATHLETICA SOCKET MOUNT

Removable socket mounting for those applications where the benches need to be regularly removed a telescopic mount design is required. Available in two sizes.

Bench Supports	22"	#101126
Bench Supports	29"	#101125

ATHLETICA FLOOR MOUNT

Concrete floor mount bench supports have a 3/8" x 6" x 6" mounting plate, pre-drilled with 5/8" holes for concrete anchors. Available in three sizes.

Bench Supports	16"	#101124
Bench Supports	20"	#101211
Bench Supports	22"	#102355

ATHLETICA WALL MOUNT BRACKET

Wall mounted bench bracket with pre-drilled mounting holes, with a size approximately 12" H x 10" D x 3" W. Powder coated black.

Wall Mount Bench Bracket	#102169
---------------------------------	----------------

Becker bench supports are constructed of zinc-plated steel and available in floor mount, angled (sleeve sold separately), and wall mount design. Custom sizes upon request. Indicated heights are nominal.

BECKER FLOOR MOUNT

1/4" x 8" x 8" mounting plate

Bench Supports	18"	#48.10180
-----------------------	------------	------------------

BECKER ANGLED BENCH SUPPORT

Bench Supports	18"	#48.10170
Bench Supports - NHL size	24"	#48.10175

BECKER WALL MOUNT BRACKETS

Single Plank	#24.10035
---------------------	------------------



FACILITY PRODUCTS

LOCKER ROOM FURNISHINGS



Becker Wall Hooks

Heavy duty 1/4" steel plate with welded pegs at 18" on center. Powder coated white, custom colors available. Standard lengths are 3', 4'-6", 6', 7'-6" with custom lengths available.



Becker Wall Mount Shelf with Coat Hooks

Formed steel angled support powder coated white with 2 x 8 black recycled plastic lumber with replaceable steel coat hooks 18" on center. Custom colors available. Standard sizes 3', 4'-6", 6', 7'-6" with custom lengths available.



Standard Clothing Hook

Heavy gauge steel rod construction with radius edges for safety with a powdercoat finish for aesthetics and durability. Pre-drilled 5/16" mounting holes.

Standard Clothing Hook #102174



Collapsible Clothing Hook

Designed to release under a load of 26 lbs (+/- 2 lbs), our collapsible, tamper-proof clothing hook complies with regulations introduced in a number of jurisdictions. Made from high strength polycarbonate and magnetically mounted.

Collapsible Clothing Hook - Grey #100066

Collapsible Clothing Hook - Beige #100140



Stick Racks

Fabricated from 3/4" HDPE, our stick racks are manufactured in-house on our CNC machine.

Free-standing is available in two standard sizes 48" holds 24 sticks, 54" holds 28 sticks.

48" Free-standing Stick Rack #32.10190

54" Free-standing Stick Rack #32.10200



Standard size holds 18 sticks. Custom sizes available.

48" Wall Mount Stick Rack #103583

FACILITY PRODUCTS

RENTAL SKATES

Softrent™ Rental Figure Skates

U.S. Sizes: 8 Youth - 15 Adult
EUR Sizes: 26-49



Jackson Softec Figure Skates

Women's sizes: 7-13 (full sizes only)
medium width
Youth sizes: 1-6 (full sizes only)
Child sizes: 8-13 (full sizes only)



Softrent™ Rental Hockey Skates

U.S. Sizes: 10 Youth - 13 Adult
EUR Sizes: 27-47



Jackson Softec Hockey Skates

Men's sizes: 7-15 (full sizes only)
medium width.
Boy's sizes: 1-6 (full sizes only)
Youth sizes: 8-13 (full sizes only)



MSR Skate Rack System

Completely transform unused or inefficient spaces with a complete rental skate storage system. Our exclusive MSR Blade Saver design helps prevent blades from rusting, extending the life of the skate. Simply provide some measurements of your room and the number of skates you wish to inventory and a customized system is designed for your space.

Available configurations:

- Wall or center room systems
- Under the counter systems
- Mobile unit systems
- Single-sided or double-sided shelves
- Single-deep or double-deep shelves



FACILITY PRODUCTS

SKATE SHARPENERS

Blackstone Skate Sharpeners

Blackstone's patented spinner system changes the way skates have been sharpened for hundreds of years. The spinner system uses a small 1" disc precision machined with an ROH or an FBV shape. These custom discs are diamond coated to dress the grinding stone with the specific shape. High quality, low maintenance machines for all levels of play. Choose from four sizes to best fit your needs.



BLACISTONE®



Blademaster Skate Sharpeners

Recognized throughout North America as the leader in the skate care industry, Blademaster offers the finest quality skate sharpening equipment as well as a full line of service products. Blademaster skate sharpeners and accessories are endorsed by the Society of Professional Hockey Equipment Managers (SRHEM) in North America and are used extensively by professional equipment managers and retailers around the world. Manufacturer's warranty is 1 year parts and labor.

Wissota Skate Sharpeners

Wissota 911 Skate Sharpener is a commercial grade portable skate sharpener made 100% in the USA. Proven to give you even edges every time right from home, "The Wissota Way."

Wissota Model 911 #80.11090



BLADEMASTER

FACILITY PRODUCTS

DEHUMIDIFICATION SYSTEMS

ARID-Ice Dehumidifiers

Indoor ice arenas require humidity control to stop several problems including fog, mold growth and dripping. Because the ice sheet cools the building, moisture-laden air from outdoors condenses on anything below the "dew point". The MS Series Desiccant Dehumidifiers solve these issues. It is a perfect solution for new construction or replacing your old mechanical dehumidifier that no longer works.



SCOREBOARDS

OES Scoreboards

From the NHL to house leagues and every level of play in-between, OES LED Video and Scoreboards has a long history of partnering with arenas to bring scoreboards, videoboards and scoring and timing solutions to ice rinks.

Whether it's a compact scoreboard to display essential game stats one customized with LED vide electronic team names and sponsor ads, OES offers model to suit every arena size and budget.



Model 6225



Model 6240



CONVERSION

ICE COVERS

ArenaDeck® Ice Cover

The best ice cover on the market today; a popular choice for a majority of NHL arenas. Heavy duty (500 psi allowable compressive strength) yet lightweight, easy to install and maintain. The finish texture provides the right amount of traction and can be easily cleaned with pressure washers or floor scrubbers. The underside waffle pattern traps air creating an insulating R-value of 2.84 and since it's synthetic, it won't absorb moisture, warp, swell or stick to the ice. Standard color is grey with an elephant skin texture. Solid panels are ideal for equipment gate locations.

- ArenaDeck® Panel - Waffle 1" x 48" x 96" 55 lbs #101430**
- ArenaDeck® Panel - Solid 1" x 48" x 96" 63 lbs #101428**



ArenaDeck® Light Duty

The cost effective, light-duty floor conversion panel designed specifically for smaller venues and community rinks to host light traffic, dry floor events. With the same waffle pattern, top surface texture and rated at 300 psi, these panels are the perfect solution for venues with fewer changeovers and smaller budgets.

- Light Duty Panel - Waffle 5/8" x 48" x 96" 30 lbs #101435**

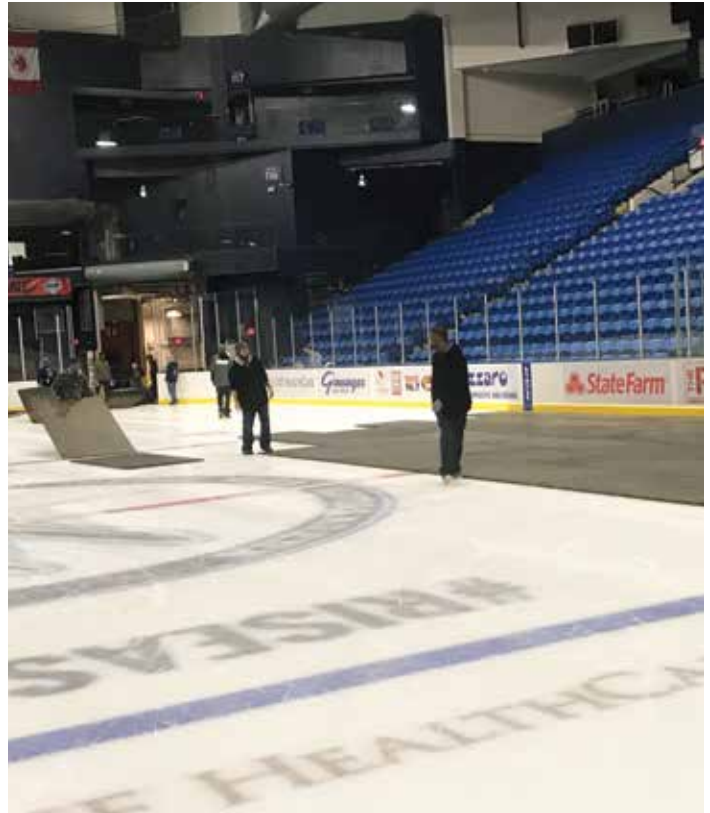
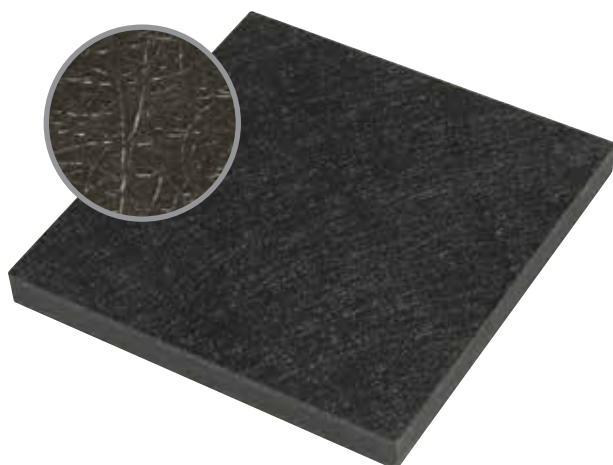

ArenaDeck® FASCOAT Ice Cover

Arena Deck XT takes the same basic panel and adds a spray coating of FASCOAT for additional grip and traction. Black only.

- FASCOAT Panel - Waffle 1" x 48" x 96" 55 lbs #101431**
- FASCOAT Panel - Solid 1" x 48" x 96" 63 lbs #101429**

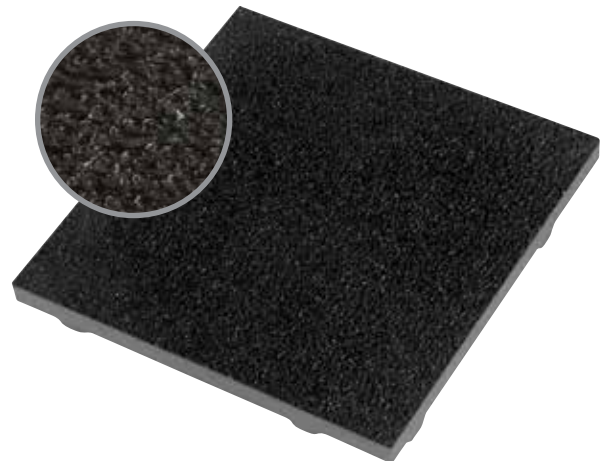

ICE DAMS AND POLY RAMPS

Steel Ice Dam

With features and benefits like these, it's no wonder the steel ice dam is fast becoming the ice dam of choice for multi-purpose arenas:

- Strong steel construction is resistant to both pressure and ice build up
- Uniformity and strength means puck rebound is consistent
- Replaceable HDPE kickplate at ice edge
- Double set of integrated dasher anchors provide 100% backup should an anchor become stripped or unuseable
- Insulated to minimize frost buildup or edge thawing
- Anchors that are prone to stripping can be easily repaired or replaced
- Designed for installation on new rinks or retrotted on existing rinks
- Laser measurements add to dimensional accuracy and higher quality

Available in 2" and 2.5" steel or stainless steel.



Poly Ice Dam

Popular for years in multi-purpose arenas, this natural white high density polyethylene dam has features not found in other ice dams:

- Cost effective
- Light weight and easy to install
- A good insulator
- Suitable for skate traffic

Commonly used in 7" widths to match dasher board panel widths and available in several thicknesses. In addition to the dasher anchors, the poly ice dam requires an additional 3 anchors per 8 feet.

Available in 1" or 2" thickness.



Poly Ramps

Durable and maintenance-free tapered poly ramps are custom machined from natural white HDPE. We offer ramps in 1", 1.5", 2", and 2.5" heights that taper down to 1/4". Available in straight or radius sections up to 10' in length.

HDPE Ramp - Straight	1.0" x 23" x 120"	#103686
HDPE Ramp - Straight	1.5" x 23" x 120"	#103687
HDPE Ramp - Straight	2.0" x 23" x 120"	#103688
HDPE Ramp - Straight	2.5" x 23" x 120"	#103689
HDPE Ramp - 28 ft Radius	1.0" x 18" x 120"	#103690
HDPE Ramp - 28 ft Radius	1.5" x 18" x 120"	#103691
HDPE Ramp - 28 ft Radius	2.0" x 18" x 120"	#103705
HDPE Ramp - 28 ft Radius	2.5" x 18" x 120"	#103706

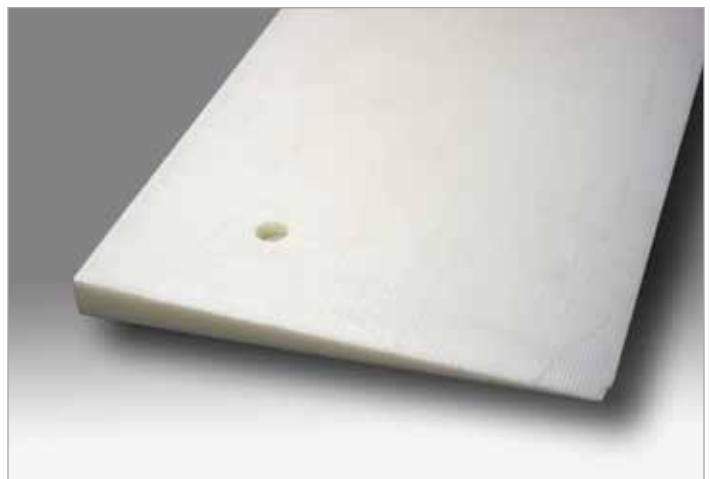

Black-out Drapes

Custom fit to your specific dasher system. Drapes include Velcro® board attachment and Velcro® drape connections. Drape lengths are dictated by gate locations in dasher layout. Fabric selections include a variety of colors and materials depending on aesthetics, durability, ease of cleaning and fire rating. Please contact us for a quote specific to your needs.

Retractable Netting Systems

Retractable systems for safety netting are available in both hand crank and motorized winch versions depending on your specific requirements. Nets retract using a bridle system and series of cables. Netting options include nylon and Kevlar protective netting. Call us for a quote.



Vinyl Runner

Provides durable protection of floors, and pointed ribbing provides maximum traction in walkways. Our vinyl runner is resistant to water and chemical damage, and will not shrink or curl over time. Rubber runner is more suitable for colder environments.

- | | | |
|------------------------------------------|--------------|----------------|
| Vinyl Runner - 1/8" x 3' x 105' | Black | #102407 |
| Rubber Runner - 3/32" x 3' x 150' | Black | #103760 |



Tunnel Covers

Retractable entrance covers tailored to your needs. Available in a variety of colors and made to fit your exact tunnel dimensions. Collapse and roll away on wheels for easy storage.



Dasher Board Padding

The standard design involves an "L" shape that folds at a 90 degree angle and extends up and over the top of the dasher board to provide maximum protection to both the face and top surfaces. These pads are available in both 3" and 5" thicknesses and heights of 42" and 48". Standard pad width is 8'. Custom sizes available upon request.



Puck Freezer

Keep your pucks consistent and frozen while travelling. For ultimate ease of transportation, the compact freezer runs off standard voltage. Digital thermostat is adjustable from -8 to 50 degrees F.

- Puck Freezer** **#102838**



Glass Lifters

Suitable for gripping and holding any smooth surface. Acrylic, tempered glass etc. up to 125 lbs max. weight. 8" diameter suction cup with a lexan handle and storage case.

Individual Glass Lifter

#101425



Forklift Attachment for Glass Lifter

Specially designed for safe and secure attachment of the electric glass lifter to standard forklift forks. Double fork capacity. Maximum load capacity of 2000 lbs.

Double Fork Model

#101302

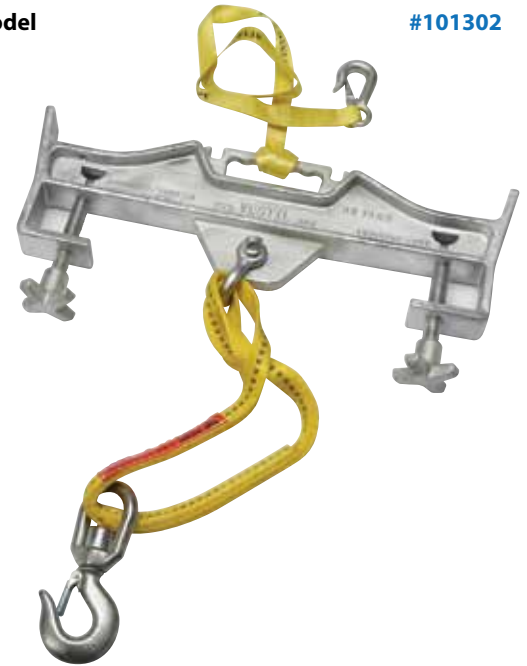

Electric Glass Lifter

A must for moving large sheets of tempered glass up to 700 lbs max. weight. A battery powered vacuum pump allows for a quick "hookup". Glass lifter frame is hinged so glass can be tilted and the shield can be rotated. Forklift rigging attachment NOT included.

Electric Glass Lifter

#101304



STORAGE CARTS

A-Frame Shielding Storage Cart

Available in two sizes to accommodate various shielding and storage room sizes. Each cart frame is constructed of welded steel and painted with strategically located white poly cladding to eliminate metal to glass contact. Two rigid and two swivel wheels allow the cart to be easily maneuvered via the welded-on towing tongues and pull handles (one each end). Two ratchet and strap assemblies are included with each cart. Maximum load capacity is 5000 lbs. *Assembly required.*

- Large A-Frame Storage Cart** **52"W x 94"H x 102"L** **#101207**
- Small A-Frame Storage Cart** **52"W x 58"H x 60"L** **#102625**



Dasher Board Storage Cart

Storage carts are constructed of a welded steel and painted frame with 6" wheels (2 rigid and 2 swivel) that have been engineered to carry maximum loads. The cart deck is covered to eliminate metal to metal contact with end rails to minimize panel shifting and damage during transport. To maximize the load capacity, 12 straight (7") dasher panels can be easily loaded side by side and upright. The unique cart design allows for cart stacking to maximize storage space. Maximum load capacity is 2000 lbs. *Assembly required.*

- Dasher Board Storage Cart** **48"W x 60"H x 96"L** **#102209**



Conversion Dasher Board Storage Cart

Constructed of welded steel and painted frame with 6" wheels that allow the cart to be easily maneuvered. Features a hinge-mounted ramp for ease of loading. Poly spaces to prevent damage to drop kick. *Dolly included.*

- Conversion Storage Cart** **#103780**



ArenaDeck® Stackable Storage Cart

ArenaDeck® storage carts are constructed of a welded steel and painted frame with 6" wheels (2 rigid and 2 swivel) that allow the cart to be easily maneuvered. The cart deck is plywood. Each cart will hold up to 50 1"H x 48"W x 96"L ice covering panels. Maximum load capacity is 2400 lbs. *Assembly required.*

- ArenaDeck® Storage Cart** **48"W x 65"H x 96"L** **#102987**



Crystaplex® HDM Cart

The cart frame is constructed of aluminum. Includes 2 cart push bars, with 2 swivel and 2 rigid caster wheels, allowing for easy movement. Holds 66 pieces of Crystaplex® HDM sleeves, Crystaplex® WIDE sleeve variant also available. *Assembly required.*

Crystaplex® HDM Cart **38"W x 48"H x 30.5"L** **#102305**



Becker Shielding Storage Cart

This heavy duty shielding storage cart features rubber mounted supports, two fixed and two swivel with brake casters, pull handle, and powder coated finish.

Shielding Storage Cart **54" L X 38" W X 62"** **#82.10110**
Shielding Storage Cart **84" L X 40" W X 87"** **#82.10120**
Shielding Storage Cart **84" L X 40" W X 63"** **#82.10115**



Slotted Acrylic Cart

The cart frame is constructed of steel with a powder coating. Includes 2 swivel and 2 rigid caster wheels, as well as tow hitch and forklift lifting channels. Holds 34 pieces of 93" long CrystaPlex® HDM sleeves, CrystaPlex® HDM WIDE sleeve variant also available, or 30 pieces of 99" long CrystaPlex® 590 Acrylic. Maximum load capacity is 6000 lbs.

Slotted Acrylic Cart **65"W x 110.5"H x 89"L** **#103478**



Curved Acrylic Cart

The cart frame is constructed of aluminum. Includes 2 cart push bars, with 2 swivel and 2 rigid caster wheels, which allow it to maneuver easily. Holds 7 complete curved acrylic assemblies and stores 4 additional HDR and 4 2C posts as well for convenience. *Assembly required.*

Slotted Acrylic Cart **65"W x 110.5"H x 89"L** **#102357**



SKILLS DEVELOPMENT

CROSS-ICE ACCESSORIES

Optimizer Rink Divider Set

The Optimizer is an aluminum framed rink divider designed for ultimate ease of installation and long wearing performance; the premier solution for arena managers, hockey coaches, and associations looking to 'divide the ice' in order to facilitate half-ice practices as recommended by various federations, including USA Hockey's American Development Model (ADM) and Hockey Canada's Cross Ice Initiation Program.

The Optimizer is available in standard 85' and 100' lengths and is shipped on its own storage cart. Designed for ease of assembly and tear down, Optimizer includes a 28" gate opening panel and standard radiused ends. Each panel measures 90" long by 36" high and is made from aluminum welded frames. Facing is white UV stabilized HDPE with a red or blue top cap. Options include a 42" high version, yellow kickplate, and netting for upper puck containment. Customized panel lengths can be ordered to fit other rink widths.

Standard set contains:

- 9 standard straight panels - 90" long
- 1 gate panel - pass through gate
- 4 radius panels (2 per end) - 78" long
- Adjustable tension buckles
- 1 storage cart

Shipping weight - 1150 lbs, 4'x 8' x 5' H single pallet.

Optimizer Rink Divider Set	36" x 85'	#101247
Optimizer Rink Divider Set	36" x 100'	#102051
Optimizer Rink Divider Set	42" x 85'	#102551
Optimizer Rink Divider Set	42" x 100'	#103538

Optimizer Storage Cart

The cart frame is constructed out of aluminum, with 4 wheels. The cart allows for ease of stowing and transportation of your Optimizer.

Optimizer Storage Cart	52"H x 48"W x 94"L	#101246
-------------------------------	---------------------------	----------------



SKILLS DEVELOPMENT

Border Patrol® Rink Dividers

Make the most of your ice time, rink programming and training effectiveness with our durable Border Patrol® Rink Dividers; designed specifically for cross-ice style training. Fast and easy to set up, the durable panels are constructed of high-density foam with a tear-resistant vinyl covering. Heavy-duty Velcro® straps securely connect the panels. The rectangular shape allows for uniform rebound and play on both sides. Great for dry-land training and intramural sport containment. Graphics can be silk screened on both sides of the panels to provide sponsorship opportunities.

BP-D Standard

Great for Mini-Mites, Mites, Squirts and zone specific drills. Optimize your rental ice time with these safe, durable and easy to set up panels. Standard color is black. Weighs 20 lbs per 10 feet.

BP-D Standard Panel	12”H x 8”W x 120”L	#101589
BP-D Standard Panel	12”H x 8”W x 60”L	#101590
BP-D 85' Standard Set	Set includes eight (8) 12” x 8” x 127.5” panels	#102031
BP-D 100' Standard Set	Set includes ten (10) 12” x 8” x 120” panels	#103580

BP-D Jumbo

Divide the ice for competitive 3-on-3 practices. Double stack against dashboards to teach safe checking techniques. Great for older, advanced players! Standard color is black. Weighs 60 lbs per 10 ft.

BP-D Jumbo Panel	22”H x 12”W x 120”L	#102037
BP-D Jumbo Panel	22”H x 12”W x 60”L	#102038
BP-D 85' Jumbo Set	Set includes eight (8) 22” x 12” x 127.5” panels	#102033
BP-D 100' Jumbo Set	Set includes ten (10) 22” x 12” x 120” panels	#103581

BP-D Pro Style

Acts as a boundary for other sports (indoor football etc.) Great for adult 3-on-3 tournaments. Standard color is black. Weighs 60 lbs per 10 ft.

BP-D Jumbo Panel	42”H x 18”W x 120”L	#102039
BP-D Jumbo Panel	42”H x 18”W x 60”L	#102040
BP-D 85' Jumbo Set	Set includes eight (8) 42” x 18” x 120” panels	#102042
BP-D 100' Jumbo Set	Set includes ten (10) 42” x 18” x 120” panels	#103582

Border Patrol Storage Cart

The cart frame is constructed out of aluminum, with 4 wheels. The cart allows for ease of stowing and transporting your Border Patrol® rink divider.

Border Patrol Storage Cart
54”H x 29”W x 73” L **#102839**



SKILLS DEVELOPMENT

Cross-Ice Goal Frame Packages

Used for cross-ice. Net and skirt included. Constructed of tubular steel with rounded corners. *Sold in pairs.*

JUNIOR GOAL FRAME PACKAGE - 3' H x 4' W x 26" D

- Collapsible #103357
- Welded - Unstrung #102836
- Welded - Prestrung #103555

MINI-MITE GOAL FRAME PACKAGE - 2' H x 3' W x 14" D

- Collapsible #101443
- Welded - Unstrung #102717
- Welded - Prestrung #103554



PERFORMANCE AIDS

Shooter Tutor

Acts as a substitute goalie when no goal tenders are available. Improve accuracy (trains players to aim for the corners and the five hole), increase goal scoring, and enhance the fun of the game with one of our durable practice goalies. Tested at -30° F, continuous 100 mph shots. Weighing only 10 lbs, it's portable and easy to store. Rolls into a 3' x 4" bundle and fits in a car trunk or equipment bag. Install and remove from nets in seconds.

- Shooter Tutor #102634

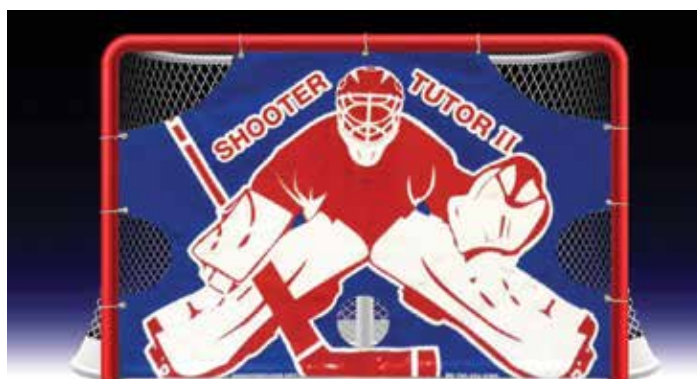

Rick-O-Shay

Never worry about the goalie not showing up when you've got "Hockey's Most Realistic Goal Blocker". Realistic 3-D contours create deflections and rebounds in random directions. Made of super durable high molecular weight polyethylene for years of indoor or outdoor play.

- Rick-O-Shay #101409



SKILLS DEVELOPMENT

Real Shot Trainer

The trainer that replicates a real goalie with 13 challenging shot spots. This durable poly board with coated hook system makes it easy to remove from goal frame.

Real Shot Trainer

#32.10375



Poly Shooting Board

Rigid polyethylene board with holes and hardware included.

Poly Shooting Board

#70.55860



Polyester Shooter Trainer

Heavy-duty 800 denier polyester with heavy metal pipe to hold to ice. Rolls up and stores easily. Attaches with bungee straps.

Polyester Shooter Trainer

#32.10350



Skate Training Aids

Metal-frame trainer helps maintain correct center of gravity for the beginner skater. Available in adult and child sizes.

27" high for child

#32.55390

42" high for adult

#32.55380



Attack Triangle

Designed to challenge players by replicating the stick and skate positions of opposing players to develop puck control, stick handling and a better understanding of passing lanes. Provides more interaction than cones and comes equipped with mooring pins to virtually eliminate sliding. **Sold individually.**

Attack Triangle

#101447



SKILLS DEVELOPMENT

BROOMBALL PRODUCTS

Broomball Goal Frames and Nets

Our broomball goal frames are a welded one-piece tubular steel construction with a red powder-coat painted finish. The nets are made of a braided 3.5mm knotted nylon with a 4" square mesh.

International Frame Size: 60" H x 80" W x 24" D

U.S. Frame Size: 72" H x 96" W x 30" D

Broomball Goal Frame	International	#40.10010
Broomball Goal Frame Netting	International Size	#40.10250
Broomball Goal Frame	U.S.	#40.10015
Broomball Goal Frame Netting	U.S. Size	#40.10255

Official Outdoor Broomball (Blue)

- Softer/easier to shoot
- High wear and performance
- Molded rubber
- Low bounce

Broomball - Outdoor #32.10025



Broom

Ideal for both training and game use. Available in red and blue color heads with 1 1/8" wood handle

Broom	Red	#32.10010
Broom	Blue	#32.10015



Official Indoor Broomball (Orange)

- National and international play
- Molded rubber
- Canadian-style
- Low bounce
- IFBA and USBA approved
- High-wear and performance

Broomball - Indoor #32.10020



Courtesy of Brian Mitchell and Pittsburgh Broomball Club

COACHING AIDS

Glass Cling Rink Diagram

Perfect coaching tool. Suggested for use on tempered glass only. Size: 24" x 30". Ask about our customizable version.

Glass Cling Rink Diagram #32.10045



Coach's Arena Wall Board

This large clear polycarbonate board is designed for wall mounting in locker rooms. Includes dry erase marker. Also available in customizable version.

Coach's Arena Wall Board Standard 24" x 32" #32.10040
Coach's Arena Wall Board Customized 36" x 48" #32.10035

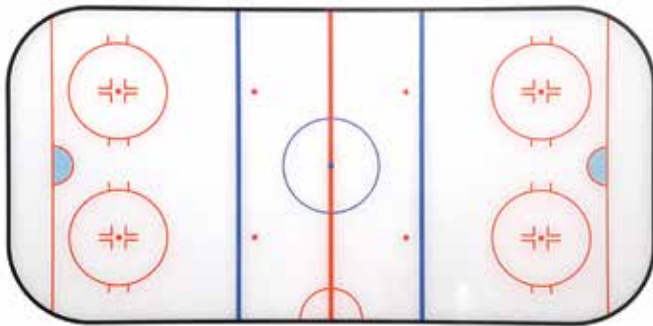

Pucks

Sold by the case.

Practice Puck 100 #32.10270
Blue Lightweight Puck 50 #32.10280
Marksless Puck 50 #32.10290
Official Game Puck - NFHS Approved 48 #32.10470



Ultimate In-Ice Coaching Aid

Durable, freeze-in rink diagram is used to illustrate plays and drills. Made from the same material as reusable Ultimate in-ice graphics size is 36" x 60". Special order sizes are available.

Ultimate In-Ice Coaching Aid #32.10030

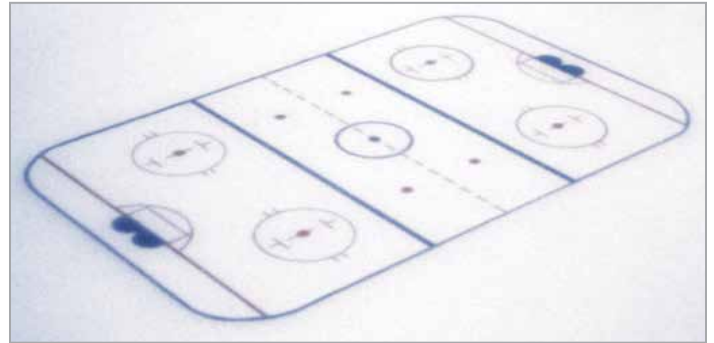

Poly Boundary Cones

These flexible, highly visible orange 12" or 18" tall markers are adaptable to most activities where zoning or boundaries are needed. Use indoors or out. Stackable for easy storage.

12" Cone #32.10440
18" Cone #32.10450



DASHBOARD REPLACEMENT COMPONENTS

ADVERTISING PANELS

Impact Ad Panels

Specially designed to withstand the continual use and abuse from pucks, players, vibration, moisture and temperature changes.

- Fabricated to precisely fit your new or existing dasher panels including gate sections.
- Panels feature bullnose edging and rounded corners to minimize errant rebounds and potential player injury.
- Panels are supplied as predrilled and countersunk or as blanks.
- Flathead screws with special hi-lo thread seat below the panel surface to provide a safe and secure attachment. Can be easily removed for graphic and message changes.
- Impact Ad panels are also available with sponsor, graphic or message decals already applied and ready to install. The decals are professionally printed and installed using customer supplied artwork files. Vibrant and long lasting but can be removed for sponsor or message change.

Impact Ad Panel	Predrilled	
.118" thick, 96"W x 33"H c/w screws		#101987
Impact Ad Panel	Blank	
.118" thick, 96"W x 36"H		#100501
Impact Ad Panel	Predrilled	
.118" thick, cut to custom size		#103678
Impact Ad Panel	No Screws	
.118" thick, 96"W x 33"H without screws		#102067

Advertising Panel Components

Polycarbonate Panel		
.118" thickness	36"W x 96"H	#100501
Polycarbonate Panel		
.118" thickness	48"W x 96"H	#100502
ABS Ad Insert Sheet		
.040" thickness	48"W x 96"H	#101783
Polycarbonate Panel		
.220" thickness	48"W x 96"H	#100505
Polycarbonate Panel		
.500" thickness	48"W x 96"H	#100509
Polycarbonate Panel		
.500" thickness	48"W x 120"H	#100508
Polycarbonate Panel		
.500" thickness	48"W x 144"H	#100011

Advertising Panel Hardware

Flathead Hi-Lo Ad Panel Screw	
#10 x 1/2"	#101105
Trusshead Bolt w/patch	
1/4" x 20 TPI	#100065
Female Insert	
1/4" x 20 TPI x 1/2"	#100064



DASHBOARD REPLACEMENT COMPONENTS

DASHERBOARD REPLACEMENT COMPONENTS



Adhesive Backed Dasher Graphic

High impact laminated graphic has a very aggressive adhesive that will adhere to any board surface. *Custom sizes available.*

Adhesive Backed Dasher Graphic 33"H x 96"W #42.10030



Polycarbonate "Drop-In" Style Dasher Ad Graphic

Printed to a water resistant, tear resistant, synthetic material.

Drop-In Dasher Ad Graphic 33"H x 96"W #42.10020

1/8" Polycarbonate Lexan Ad Cover 33"H x 96"W #82.10170.1



Banner Advertising

Full color banners, digitally printed on one or two sides. Made from a durable moisture resistant vinyl. You choose either square or chevron; pole or grommet style. Great for sponsorship or championships! *Sold by the square foot.*

Banner Advertising

#42.10010

Resurfacer Advertising

Digitally printed for one-of-a-kind graphics. *Sold by the square foot plus installation.*

Resurfacer Advertising

#42.10140



DASHERBOARD REPLACEMENT COMPONENTS

DASHBOARD REPLACEMENT COMPONENTS

DASHBOARD CLADDING, BACKER, KICK PLATE AND CAPRAIL

CrystaPlex® StayWhite® Dasherboard Cladding and Backer Panel

High density polyethylene dasherboard cladding pigmented "bright white" and specially designed for high impact ice arena applications. Only virgin polyethylene is used for its consistent color and strength.



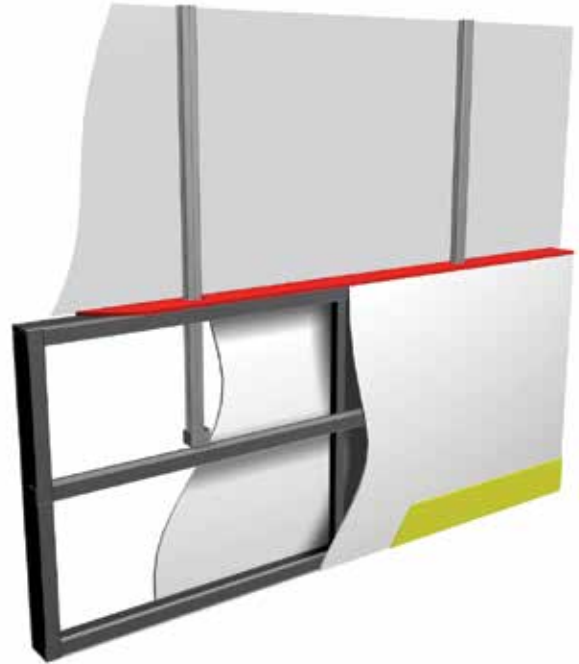



.220" thickness	42" H x 96" L	#102933
.375" thickness	42" H x 96" L	#102011
.500" thickness	42" H x 96" L	#102021
.375" thickness	48" H x 96" L	#102010
.500" thickness	48" H x 96" L	#102017



Kick Plate

The same high density virgin polyethylene as the dasher board cladding. Standard 1/2" kick plate has bullnosed top edges. Predrilling available upon request. Other kick plate thicknesses also available upon request.



STANDARD SHEET SIZES:

Standard Yellow Kick Plate			
.220" thickness	8"H x 96"L		#102006
Standard Yellow Kick Plate			
.500" thickness	8"H x 96"L		#102436
Standard Gold Kick Plate			
.220" thickness	8"H x 96"L		#102008
Standard Gold Kick Plate			
.500" thickness	8"H x 96"L		#102425
Standard Light Blue Kick Plate			
.220" thickness	8"H x 96"L		#102007
Standard Light Blue Kick Plate			
.500" thickness	8"H x 96"L		#101998

ICE DAM KICKPLATE:

Ice Dam Yellow Kick Plate			
.500" thickness	1.5"H x 96"L		#103342
Ice Dam Yellow Kick Plate			
.500" thickness	2"H x 96"L		#101908
Ice Dam Yellow Kick Plate			
1" thickness	1.5"H x 96"L		#102109
Ice Dam Yellow Kick Plate			
1" thickness	2"H x 96"L		#101890

BOARD KICKPLATE:

Board Yellow Kick Plate			
.500" thickness	8"H x 96"L		#102916
Board Yellow Kick Plate			
.500" thickness	8.5"H x 96"L		#103498
Board Yellow Kick Plate			
.500" thickness	10"H x 96"L		#103584











DASHBOARD REPLACEMENT COMPONENTS

DASHERBOARD REPLACEMENT COMPONENTS

Caprail

High density virgin polyethylene caprail with bullnosed top, front and rear edges. Available in straight or radius sections and custom CNC cut to size. Available finishes are smooth and "orange peel" to hide scratches.

STANDARD SHEET SIZES:

Red, .500" thickness	48" x 96"	
Red, .750" thickness	48" x 96"	
Red, 1" thickness	48" x 96"	
Blue, .500" thickness	48" x 96"	
Blue, .750" thickness	48" x 96"	
Blue, 1" thickness	48" x 96"	
Gold, .500" thickness	48" x 96"	
Gold, .750" thickness	48" x 96"	
Gold, 1" thickness	48" x 96"	



Becker Poly Line Kits

Our standard red and blue polyethylene line kit is available in 1/4" and 1/2". An example of a basic kit includes the following and can be adjusted to fit your needs. All pieces are available to be purchased separately.

1/4" Full Line Kit	#70.22840
1/2" Full Line Kit	#70.22830
1/4" Kickplate Only Kit	#70.22810
1/2" Kickplate Only Kit	#70.22820



Crystaplex® Game Line Kits

Includes pre-cut poly red and blue lines, ready for installation into dasher cladding. Line components also sold separately. Available in 1/4" and 1/2" thicknesses.

Complete Kit - 1/4"	#103516
Complete Kit - 1/2"	#102788
Red Goal Line Kit - 1/4" - Red HDPE - .25" x 2" x 48"	#102002
Red Goal Line Kit - 1/2" - Red HDPE - .50" x 2" x 48"	#102009
Red Line Kit - 1/2" - Red - 12" x 48" (piece only)	#102004
Red Line Kit - 1/2" - Red - 12" x 7.875" (kick only)	#102002
Blue Line Kit - 1/2" - Red - 12" x 48" (piece only)	#102005
Blue Line Kit - 1/2" - Red - 12" x 7.875" (kick only)	#102003



DASHBOARD REPLACEMENT COMPONENTS

Line Backer Kit with Fasteners

Eliminate the common problem of cracked facing with the optional 3/8" white poly backer. Backer pieces are precut to size and come complete with attachment screws.



Threshold

Natural white high density polyethylene sheet is ideal for gate thresholds and other high impact ice arena applications. Available in standard and precut sizes. Other sizes available upon request.

.75" thickness	White	48" x 96"	#100470
1" thickness	White	48" x 96"	#100279
1" thickness	Natural	48" x 120"	#100270
1 1/2" thickness	Natural	48" x 96"	#100283
1 1/2" thickness	Natural	48" x 120"	#100281
2" thickness	Natural	48" x 96"	#100287
2" thickness	Natural	48" x 120"	#100284
.75" thickness	Straight	7" x 120"	#70.55280
.75" thickness	Radius	7" x 120"	#70.55270.28
1" thickness	Straight	7" x 120"	#101884
1" thickness	Radius	7" x 120"	#101887
1 1/2" thickness	Straight	7" x 120"	#101883
1 1/2" thickness	Radius	7" x 120"	#101886



SoftCap® Flexible Caprail

Our SoftCap® caprails are made using flexible thermo-plastic elastomers for a more forgiving surface that will help reduce the chance of player injury when in contact with your rink boards. Testing indicates that our SoftCap® is 96% more flexible and compressive than current HDPE top caps. Comes with a 1/2" NHL bullnose front edge.

Red, 1" thickness	2-1/4" x 96"	#100628
Red, 1" thickness	3-3/4" x 96"	#100633
Red H-clamp		#100637
Dark Blue, 1" thickness	2-1/4" x 96"	#100626
Dark Blue, 1" thickness	3-3/4" x 96"	#100630
Dark Blue H-clamp		#100639
Black, 1" thickness	2-1/4" x 96"	#100625
Black, 1" thickness	3-3/4" x 96"	#100629
Black H-clamp		#100638

Custom 12" Red and Blue Lines

Display your team or arena logo within the red or blue lines of your rink. Durable hi-density dasher facing material is CNC machined to match your logo and inlaid into the lines just like in the professional arenas. Great looking and made to take the abuse. Please email a copy of your logo for quote request.



Crystaplex® Quick Release Brackets

Bolted directly to the panels and clipped into the dasher frames, dasher board panels can be removed quickly with the actuation of a 1/4" dowel. Designed specifically for use on 3/4" and 1" thick caprail on CrystaPlex® dasher systems. 4 brackets required per panel.

Upper Bracket	#100164
Lower Bracket	#100165

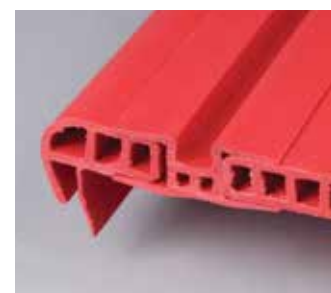

DASHBOARD REPLACEMENT COMPONENTS

DASHERBOARD REPLACEMENT COMPONENTS

UVEEBOARD® Outdoor Puckboard

Durable and long lasting, all-purpose UveeBoard dasherboard cladding is the ultimate outdoor puckboard for all-weather outdoor and indoor use. UveeBoard offers superb resistance to degradation from UV exposure, very low coefficient of expansion and contraction and has superior cold temperature impact ratings due to its special resin composition; it looks, feels and cuts like conventional HDPE. Used in facing, caprail and kick plate applications in your choice of 4 colors: blue, gold, white or yellow. Sheet sizes available in 1/4" or 3/8" thickness.

Kickplate sizes available in 1/4" or 1/2" thickness.

.220" thickness	42" W x 97"	#100289
.375" thickness	42" W x 98"	#100299
.375" thickness	48" W x 98"	#100305
.500" thickness	48" W x 98"	#100308
.500" thickness	42" W x 98"	#100317

Fiberglass Dasher Facing

Recommended thickness for ice hockey is 3/8", 1/4" for inline hockey.

STANDARD SHEET SIZES:

.250" thickness	40-7/8" x 96"	#101261
.375" thickness	40-7/8" x 96"	#101263
.250" thickness	48" x 96"	#101262
.375" thickness	48" x 96"	#101264

Fiberglass Kick Plate

Available in various thicknesses upon request.

STANDARD SHEET SIZES:

Gold	.250" thickness
8" x 96"	#102437
Gold	.250" thickness
6" x 96"	#101977



DASHBOARD REPLACEMENT COMPONENTS

Tempered Glass

Tempered glass is commonly used in community arenas:

- Scratch resistant
- Easy to clean
- Use with supportless systems

Standard glass comes "arena-ready" with radius top corners and flat-ground edges and is available in 5/8" or 1/2" thickness. Custom sizes also available. Speaker and media holes are also available.



Acrylic Shielding

Acrylic shielding is the industry standard in competitive multi-use arenas with frequent changeovers.

- Flexible and lightweight
- Easy to store
- Use with conversion systems

Fabricating shielding to "arena-ready" with top two corners rounded and exposed edges bullnosed is recommended to minimize breakage.

Whatever you need, we can supply full-sheet, cut-to-size, and arena-ready acrylic shielding in these options:

Crystaplex® 590 Plus

This material has been successfully tested by Athletica Sport Systems, approved for use by the NHL.

STANDARD SHEET SIZES:

51" x 100"	#100491
60" x 96"	#100492
75" x 100"	#100493

Crystaplex® 545" Acrylic

STANDARD SHEET SIZES:

50" x 99"	#103518
62" x 99"	#103519
74" x 99"	#103520

12mm (.472") Acrylic

This product is an alternative to 1/2" glass, providing a transparent solution.

STANDARD SHEET SIZES:

48" x 96"	#100482
60" x 96"	#100483
72" x 96"	#100484

Polycarbonate shielding in 3/8" and 1/2" is available on request.



What is Crystaplex® 590 Plus acrylic?

At Athletica Sport Systems, we take the science of sport seriously; we know that as technology has made hockey sticks lighter and slapshots faster and harder than ever, flimsy shielding doesn't cut it. That's why we only use Crystaplex® 590 Plus acrylic in our seamless acrylic shielding systems.

Not all acrylic shielding is created equal. In some cases, what is referred to as "half-inch" thickness may in fact be as thin as .472" thick.

The Crystaplex® 590 Plus acrylic is guaranteed always to be between 0.585 inches and 0.620 inches thick.

You get all the advantages of lightweight acrylic with lasting durability you need in your dashboard shielding.



DASHERBOARD REPLACEMENT COMPONENTS

Crystaplex® HDR Heavy-Duty Quick Release Shield Support

Specially designed for use by multi-purpose facilities where change-over speed is critical, one person can remove shielding from ice side by unhooking the faceplate. Flat profile faceplate minimizes unusual puck deflections. Use with B110 gaskets and B94 gaskets.

STANDARD SIZES (overall length/height above cap rail):

3' Shielding	35" Face / 54.375" Back
4' Shielding	47" Face / 66.375" Back
5' and 6' Shielding	59" Face / 78.375" Back
7' and 8' Shielding	83" Face / 102.375" Back

Crystaplex® Mark VI Shield Support

Requires only one person with a screw gun for shield installation or removal from ice side. Springnut channel design prevents stripping common with tapped bolt designs. Use with B110 gaskets and B94 gaskets.

STANDARD SIZES (overall length/height above cap rail):

3' Shielding	35" Face / 56.5" Back
4' Shielding	47" Face / 68.5" Back
5' and 6' Shielding	59" Face / 80.5" Back
7' and 8' Shielding	83" Face / 104.5" Back

Crystaplex® HDM Sleeve

Engineered for seamless acrylic installations, the HDM sleeve is constructed of flexible polycarbonate for maximum player safety. Transparent design allows for increased fan experience.

69"	#103488
93"	#103487

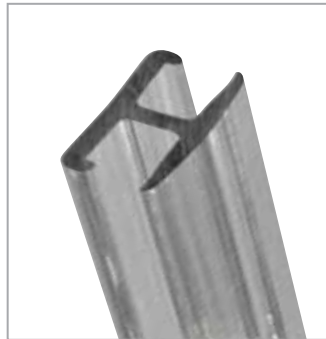

Crystaplex® 2C Shield Support

Used for right angle turns and shield termination points at box corners or gate locations. Use with B110 gaskets and B94 gaskets.

STANDARD SIZES:

3' Shielding	59"
4' Shielding	71"
5' and 6' Shielding	83"
7' and 8' Shielding	107"

(14' lengths also available)

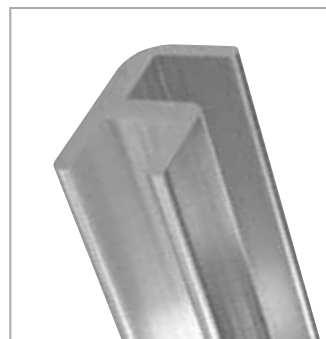

Crystaplex® Mark IV Shield Support

Standard one-piece shield support for .500" shields only. Used on both inline and ice hockey rinks with support. Use with Mark IV plastic U-channel gasketing.

STANDARD SIZES:

3' Shielding	55"
4' Shielding	67"
5' Shielding	79"



Crystaplex® HDM Wide Sleeve

Built with flexible transparent polycarbonate and engineered for seamless acrylic installations, the CrystaPlex® HDM wide sleeve can be retrofit with existing shielding.

69"	#103680
93"	#103490

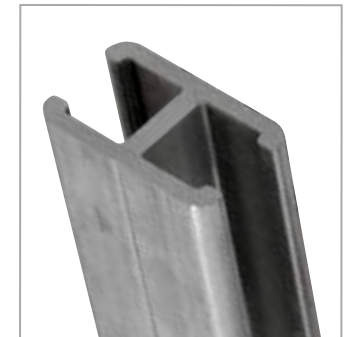

Clearvision Support

Clear Vision Supports minimize viewing obstruction and provide for more flexible shielding. Supports do not require gaskets. Unique design allows for quick shielding removal.

111"	#102824
87"	#102825



DASHBOARD REPLACEMENT COMPONENTS

Crystaplex® HDS Post

Increase player safety with an easy retrofit from aluminum CrystaPlex® HDR post and Pro Series™ shield support. Flexible polycarbonate shielding support engineered specifically for Crystaplex® 590 Plus acrylic shielding. More flexible option. Glazing gaskets not required. Custom colors available.

118"

#102696



Pro Series™ End Shield Supports

Removable faceplate allows for ease of shielding replacement. End supports are used at shielding termination locations and on gate doors. Standard posts will support 1/2" and 5/8" shielding - tempered glass or acrylic.

STANDARD SIZES:

4' Shielding	36" Face / 60" Back
5' Shielding	48" Face / 72" Back
6' Shielding	60" Face / 84" Back
7' Shielding	72" Face / 96" Back



Pro Series™ Corner Shield Supports

Removable faceplate allows for ease of shielding replacement. Corner supports are used at player, penalty and timer box locations. Standard posts will support 1/2" and 5/8" shielding - tempered glass or acrylic.

STANDARD SIZES:

4' Shielding	36" Face / 60" Back
5' Shielding	48" Face / 72" Back
6' Shielding	60" Face / 84" Back
7' Shielding	72" Face / 96" Back



Pro Series™ Mullion Shield Supports

Removable faceplate allows for ease of shielding replacement. Standard posts will support 1/2" and 5/8" shielding - tempered glass or acrylic.

STANDARD SIZES:

4' Shielding	36" Face / 60" Back
5' Shielding	48" Face / 72" Back
6' Shielding	60" Face / 84" Back
7' Shielding	72" Face / 96" Back



DASHBOARD REPLACEMENT COMPONENTS

Becker Aluminum Shield Supports

Shield support uprights are constructed of solid extruded aluminum with clear anodized finish. Furnished complete with shield gaskets, these supports are available in various configurations to meet your specific needs. Standard and custom shield support lengths available.

Becker Two Piece H-Channel

Cut to desired lengths.

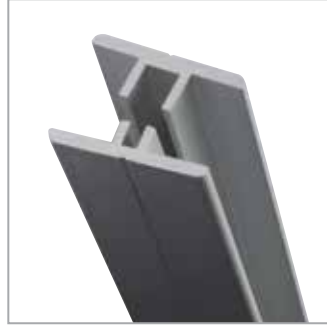

Becker Termination Post

Used at gate locations.

3/4' Shielding	47 1/8"
5' Shielding	59 1/8"
6' Shielding	71 1/8"
7' Shielding	83 1/8"
8' Shielding	95 1/8"

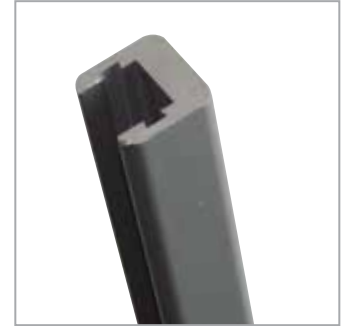

Becker Round with Face Plate

The standard post used for the Becker 6.0 system, round design with two-piece construction.

3/4' Shielding	34 1/2" Face / 55 5/8" Round
5' Shielding	46 1/2" Face / 67 5/8" Round
6' Shielding	58 1/2" Face / 79 5/8" Round
7' Shielding	70 1/2" Face / 91 5/8" Round
8' Shielding	82 1/2" Face / 103 5/8" Round



Becker Quick Release Shield Support

Designed for multi-venue facilities where quick change out of shielding is required.

6' Shielding	70 1/2" Face / 90 3/8" Round
6' w/ Cushion	70 1/4" Face / 90 3/8" Round
8' Shielding	94 1/2" Face / 114 3/8" Round
8' w/ Cushion	94 1/4" Face / 114 3/8" Round



Becker C-Channel

Cut to desired lengths.

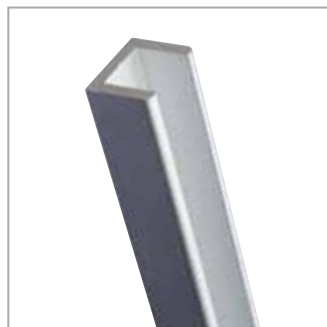

One piece H-Channel

Cut to desired lengths.

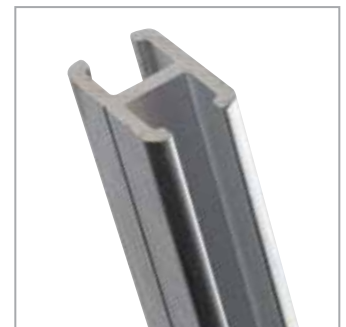

Shielding Gaskets

Vinyl gasketing is available for 1/2" and 5/8" shielding in 6', 8', and 10' lengths.

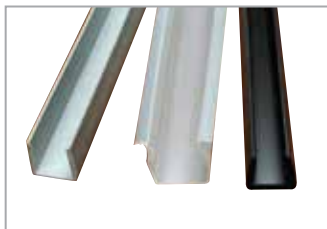

DASHBOARD REPLACEMENT COMPONENTS

Plastic Sill Channel

Used on top of the caprail to support and protect shielding or at shielding termination points.

- Sill channel Red** #102202
- Sill channel Blue** #102203



Glass Spacer Blocks

Revised design is sized properly to provide appropriate seamless glass spacing and at the same time fit within the seamless channel to minimize obstruction. Spacer blocks are durable white HDPE. Suitable for permanent rinks.

- Glass Spacer Blocks Bag of 20** #101988



Crystaplex® 2C Cups

Zinc plated steel construction. Mounts to center stringer and holds "2C" in place. Sold individually.

- LH mount design** #100189
- Center mount design** #100188
- RH mount design** #100190

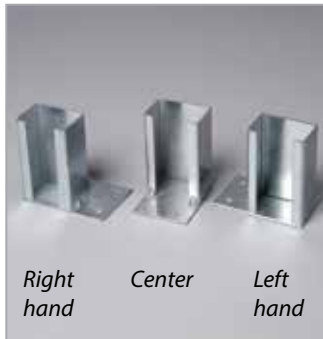

Crystaplex® Replacement Bolts for Mark VI Supports

Replacement parts available to replace the occasional lost or stripped screw. Special 1/4" spring nut locks into the slot on the back of the Mark VI post.

- 1/4" Springclip nut** #100908
- 1/4" FH screw** #101931



Crystaplex® HDR Sockets

Zinc plated steel construction. Angle mount design attaches to center stringer and holds HDR support in place. Sold individually.

- Angle mount** #100191
- Flush mount** #100193



Crystaplex® J-Brackets

Sold individually and model is dependent on caprail thickness.

- 1/2" Caprail thickness Red** #101074
- 3/4" Caprail thickness Yellow** #101075
- 1" Caprail thickness Blue** #101073



Crystaplex® Replacement Pins for HDR Support

Replacement roll pins for the quick release HDR support posts.

- Replacement Pins Bag of 100** #101081



DASHBOARD REPLACEMENT COMPONENTS

DASHERBOARD REPLACEMENT COMPONENTS

Supported Shielding Gasketing

Protects shielding within aluminum shield supports.

Crystaplex® B94 Gasket

Use with Crystaplex® HDR, 2C and Mark VI support and aluminum C-channel.

.625" Black 120" #100607

Crystaplex® B110 Gasket

Use with Crystaplex® HDR, 2C and Mark IV support and aluminum C-channel.

.500" White 120" #100606

Crystaplex® Mark IV Gasket

Use with Crystaplex® Mark IV support only.

.500" Clear 72" #100624

Crystaplex® 6A Seamless Gasketing

Protects shielding within seamless glass channel, speeds replacement of broken shielding and closes gap areas for safety.

.500" White 48" #100609

.625" Black 48" #100611

GlassFlex® Base Gasketing

3 1/2" U-height. Custom colors available.

.500" Black 48" #100617

.500" Red 48" #100622

.500" Blue 48" #100616

.625" Black 48" #100621

.625" Red 48" #100623

.625" Blue 48" #100620

.625" Black 96" #100615

.625" Red 96" #100619

.625" Blue 96" #100614

Vertical Edge Gasketing

U-channel gaskets used on all GlassFlex® systems with tempered glass at vertical edges of glass. Color: Clear.

.500" x .9" Clear 250 ft #100610

.625" x .9" Clear 250 ft #100612

Gasket Tape

Allows easy changeovers when removing shielding. Adheres gaskets to shielding. Clear, double-sided tape in 180 ft roll.

- Special resistance to cleaning solutions

1" Clear 180 ft #101423



B94



B110



Mark IV



Pro Series™ Spline Gasket

1/8" black compression gasket. Sold per foot.

Pro Series Spline Gasket #100613



DASHERBOARD REPLACEMENT COMPONENTS

CheckFlex® HairPin Polycarbonate Clip

Allows two adjacent seamless glass shields to move in conjunction with one another to maximize overall impact absorption. One size universal clip fits straight and radius areas and 1/2" or 5/8" shielding. *Sold individually.*

CheckFlex® HairPin Polycarbonate Clip #100048



Clear Vision Clip

Clips for Clear Vision supports provide additional support to shielding.

Clear Vision Clip #101847



Crystaplex® HDR Butterfly Clips - Wide Vision Shielding

Butterfly clips for HDR supports in Wide Vision shielding designs provide additional support and engagement for shielding. Clips fit the contour of the spectator side of the HDR support and attach with screws.

HDR Butterfly Clip #101398



GlassFlex® Clip

3rd generation seamless glass clip designed specifically for optimum movement of GlassFlex® shielding system. Large surface area helps prevent the clips from dislodging off the glass. One size clip fits both 5/8" and 1/2" thick shielding. *Sold individually.*

Straight Clip #101402
Radius Clip #101399



Glass Spacer Clip

Original design U-shape spacer clips provide proper spacing of seamless glass. One size fits both 1/2" and 5/8" shielding. Suitable for multi-purpose rinks. *Sold individually.*

Glassflex H Block Straight #101299
Glassflex H Block Radius #101300
Glass Spacer Clip #101424

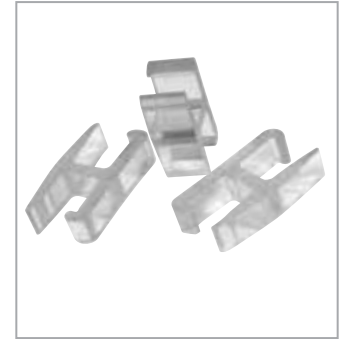

Crystaplex® HDM Sleeve Butterfly Clips

Butterfly clips for HDM supports provide additional support shielding.

Straight #101279
Radius #101140
HDM Wide straight #103461
HDM Wide angled #103462
J-Bolt for attachment #100873

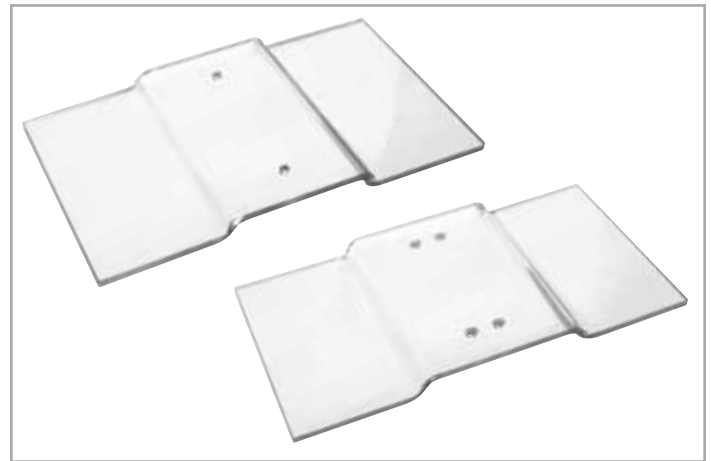

Vision Supportless Shielding Clips and Gasket

Shielding Clips #82.22010
Clear H Cushion for 1/2" Glass #90.10090
Clear H Cushion for 5/8" Glass #90.10094

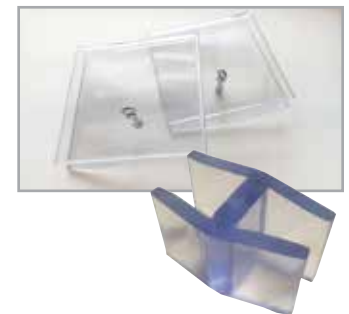

DASHBOARD REPLACEMENT COMPONENTS

Crystaplex® Curved Acrylic Replacements

Working in collaboration with the NHL and its independent engineering firm, our Curved Acrylic Termination Assembly was approved by the NHL and selected by the majority for install. The Curved Acrylic Terminations improve player safety, as they flex upon impact dramatically decreasing the risk of serious injury.

Keep yours up to date when parts need to be replaced.

Replacement curved acrylic only - with springs and channels:

60"	#102073
72"	#102072
96"	#103397

Faceplate:

60" left hand	#102307
72" left hand	#101864
96" left hand	#103396
60" right hand	#102308
72" right hand	#101863
96" right hand	#103395

Post with backwing:

60" left hand	#103585
72" left hand	#103586
60" right hand	#103384
72" right hand	#102884

Backwing hardware:

1/4"	#100920
-------------	----------------

Polycarbonate retainer:

Top retainer strip	#102306
---------------------------	----------------



Corner Shielding Pad

Designed for indoor and outdoor use, our 3" closed cell foam protects hockey players and helps to reduce injuries and liability by padding terminations in the shielding. Ideal for use at player and penalty boxes. Also available in 60" high. Available in blue, red, white, black or custom.

Red	36" high	#103647
Blue	36" high	#103646
Black	36" high	#103649
White	36" high	#103648
Custom	36" high	#103645
Red	48" high	#103652
Blue	48" high	#103651
Black	48" high	#103654
White	48" high	#103653
Custom	48" high	#103650

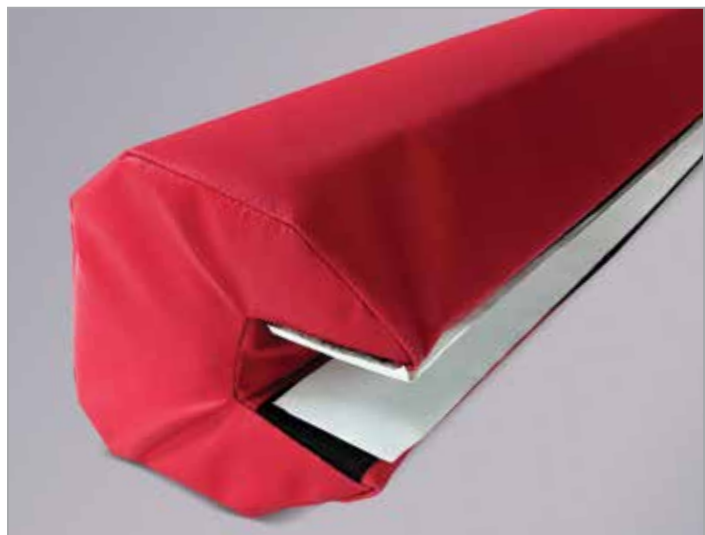

DASHBOARD REPLACEMENT COMPONENTS

Termination Pad

NHL approved padding, with dual durometer foam core. Attaches to support with pressure sensitive adhesive Velcro. Standard length: 48". Colors: Red, Blue and Black. Available in 2C wide and 2C narrow versions.

2C wide:

Red	#101365
Blue	#101361
Black	#101362

2C narrow:

Red	#101333
Blue	#101329
Black	#101330



Universal Flat Pad - Open Cell

Heavy-duty 18 oz. reinforced fabric sleeve with impact-absorbing foam core sealed inside. Pad is 12" wide and wraps around the end of the shielding/post to cushion the edge. Flat pad comes with separate pressure sensitive Velcro® strips, which are field installed to the existing shielding and matching the location on the pad. Standard length: 36" and 48" high.

Red	36" high	#103595
Blue	36" high	#103596
Black	36" high	#103597
White	36" high	#103598
Custom	36" high	#101296
Red	48" high	#103600
Blue	48" high	#103601
Black	48" high	#103602
White	48" high	#103603
Custom	48" high	#101297



Traditional Round Pad

Heavy-duty 18 oz. reinforced fabric sleeve with impact-absorbing foam core sealed inside. Mounts to termination support by wrapping around 1-3/4" diameter post. 2" wide Velcro® straps secure pad in place. Standard length: 36" and 48" high

Red	36" high	#103604
Blue	36" high	#103605
Black	36" high	#103606
White	36" high	#103607
Custom	36" high	#101411
Red	48" high	#103608
Blue	48" high	#103609
Black	48" high	#103610
White	48" high	#103611
Custom	48" high	#101412



DASHERBOARD REPLACEMENT COMPONENTS

LATCH COMPONENTS

Crystaplex® Latch Set

Simple and effective design, proven in professional arenas. Bolt-on design allows for ease of adjustment. Universal design works on both LH and RH doors. Only one latch per door required. Standard latch, catch, door stop and ice side release sold separately.

Standard Latch	Zinc	#100181
Standard Catch	Zinc	#100184
Door Stop	Zinc	#100169
Standard Latch	Stainless Steel	#100182
Standard Catch	Stainless Steel	#100185
Door Stop	Stainless Steel	#100170

Crystaplex® Replacement Release for Latch

Original design - spring-loaded push rod/plunger assembly that connects to Crystaplex® gate latch set. Push button size is 4 x 1".
Sold individually.

Replacement Release Latch #101917



Crystaplex® Spring Loaded Release

Spring loaded plunger. Connects to Crystaplex® gate latch set.
Sold individually.

Spring Loaded Release #103356



Becker Lift Latch

Zinc-plated welded construction. Catch designed with elongated holes for proper alignment. Sold with or without push button feature, this heavy-duty lift latch is suitable for daily use. Fasteners included.
Sold individually.

Lift Latch with Push Button #48.22460
Lift Latch without Push Button #48.22420

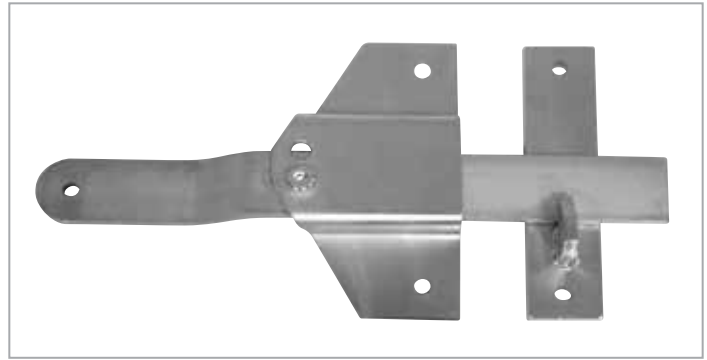
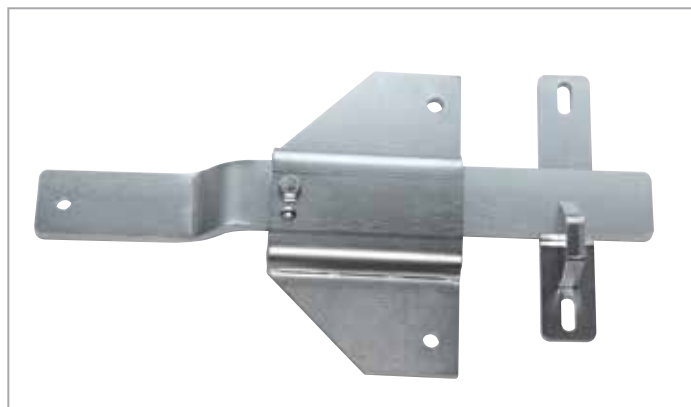

Crystaplex® Ice Side Release for Latch

New style push button assembly utilizes a machined HDPE housing and button. Smoother operation and no lubrication required. Push button size is 4 x 1". Can be retrofitted onto previous model Crystaplex® ice side release mechanisms with a slight modification to framing required.
Sold individually.

Ice Side Release Latch #100195



Becker Spring Latch

Replacement latch for previous BAP6.0 designs. This latch system is available with or without push button. *Sold individually.*

Spring Latch without Push Button #48.22730
Spring Latch with Push Button -Left #48.22520
Spring Latch with Push Button -Right #48.22530

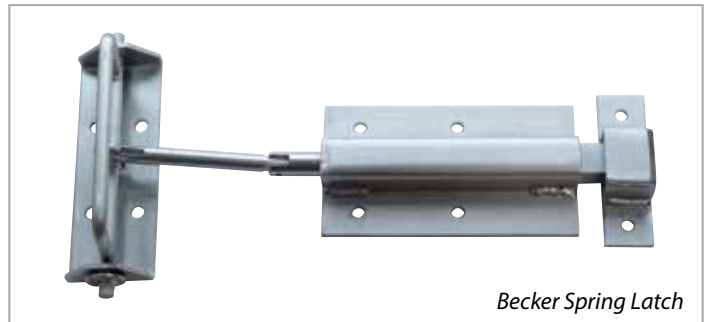

DASHERBOARD REPLACEMENT COMPONENTS

DASHBOARD REPLACEMENT COMPONENTS

Becker Personnel Latch

Three piece system for previous BAP6.0 design. Choose from single or double latch. *Sold individually.*

Personnel Gate Hinge Assembly	#44.55270
Personnel Gate Latch - Single	#44.55240
Personnel Gate Latch - Double	#44.55280



Pro Series™ Latch Bar Assembly

Assembly includes handle, retainer and strike plate. Available in stainless steel or zinc plated. *Sold individually.*

Latch handle Assembly	Stainless	#100115
Latch handle Assembly	Zinc	#100116
5" strike plate	Stainless	#100105
5" strike plate	Zinc	#100106
Latch retainer Assembly	Stainless	#100113
Latch retainer - Assembly	Zinc	#100114

Pro Series™ Rinkside Release

Rinkside release for latch bar assembly. *Sold individually.*

Stainless Steel	#100121
Zinc Plated	#100122



HINGE COMPONENTS

Crystaplex® 8" Heavy-Duty Adjustable Hinge

Built-in adjustment feature simplifies alignment and installation. Designed specifically for machine gates.

Hinge	Zinc	#100175
Hinge	Stainless Steel	#100176
Pins	Zinc	#101971
Pins	Stainless Steel	#102628

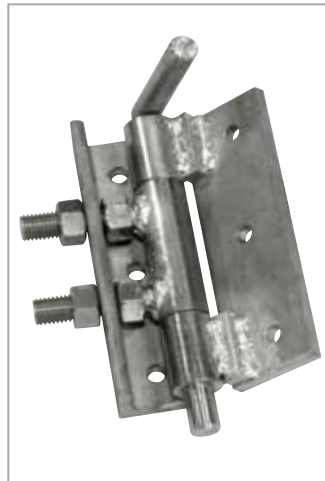

Becker Heavy Duty Hinge

3/8" reinforced steel hinge with customizable strap size. *Sold individually.*

Heavy Duty Hinge	#44.22010
-------------------------	------------------

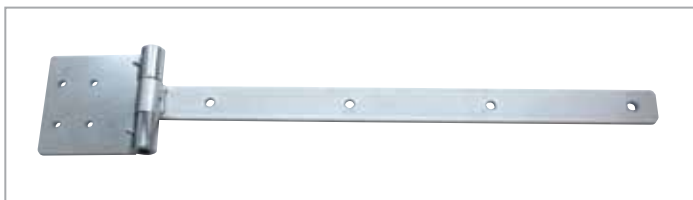

Self-lubricating Pin-hinge

3/4" heavy duty pin diameter. Bolt-on design provides for adjustment. Plastic bushing eliminates the need for lubrication and provides smooth operation. For use with all single leaf access gates. Pin and socket sold separately. Universal design for both LH and RH doors.

Pin	#100177
Socket	#100179



Crystaplex® Replacement Self-lubricating Bushings Only

Replacement poly bushings for original equipment self-lubricating pin hinges. Bushings are pressed into hinges. *Sold individually.*

Bushing	#101872
----------------	----------------



DASHERBOARD REPLACEMENT COMPONENTS

Becker Bolt On Gate Hinge

5" hinge for Becker systems.
6" backer plate included.

Sold individually.

**Bolt-On Steel Gate Hinge
Left Hand #48.10051**

**Bolt-On Steel Gate Hinge
Right Hand #48.10061**



Becker Adjustable Gate Hinge

8" hinge with 3/4" diameter pin used for easy gate alignment.
Sold individually.

**Heavy Duty Adjustable Hinge
#44.10020**



Pro Series™ Hinge

5" replacement hinge for Pro Series man gates.

Sold individually.

Stainless Steel #100123

Zinc Plated #100112



Access Gate Hinges

Piano hinges are simple and effective, providing continuous support to door frames. Slim profile, perfect for team boxes where players jump over the boards. Hinges are pre-punched with 3/8" diameter mounting holes. 28" model has removable hinge pin and no holes. Three standard models to choose from. *Sold individually.*

28" long x 6" open width

Zinc #100172

28" long x 6" open width

Stainless Steel #100173

32" long x 6" open width

Zinc #44.10322

36" long x 6" open width

Zinc #44.10325



Pro Series™ Self Closing Gate Hinge

Only available on Pro Series dashers. *Sold individually.*

Hinge #101550

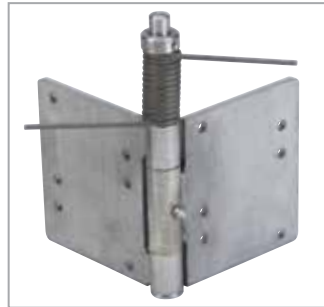

BOLTS

Cane Bolt

Ultra heavy duty 5/8" dia x 12" long solid steel pins. Used to lock the base of the doors into the gate threshold. Bolt on mounting brackets included. *Sold individually.*

Cane Bolt #105325



Becker Cane Bolt Assembly

14" tall zinc-plated, externally mounted design used to secure gate leafs. Includes top and bottom guide and 11" cane bolt. *Sold individually.*

**Cane Bolt Assembly - Left
#44.55061**

**Cane Bolt Assembly - Right
#44.55062**



Cane Bolt Assembly - Right

Flush Bolt with Extended Pin

Stainless steel with blue handle and extended pin. *Sold individually.*

Flush Bolt #100548



DASHERBOARD REPLACEMENT COMPONENTS

CASTERS

Crystaplex® Equipment Gate Casters

Caster is spring loaded to compensate for uneven concrete and includes mounting plate. 5" dia. swivel caster wheel with a 700 lb capacity. *Sold individually.*

Complete Caster Assembly	Zinc	#102430
Complete Caster Assembly	Stainless Steel	#102359
Equipment Gate Install Kit		
- Includes mounting angles, screws, washers and nylon nuts		
		#102431

Swivel Model Replacement Caster

2" x 5" Caster Wheel Only	Zinc	#101875
Axle Bolt Only	Zinc	#101879

Access Gate Caster

For use with gates up to 36" wide. Lighter duty for single leaf access gates. 3" dia. swivel caster. Caster is spring loaded to compensate for uneven concrete. Caster is factory preassembled and includes mounting plate. *Sold individually.*

Access Gate Caster	#102085
---------------------------	----------------



Becker Caster Assembly

Sold individually.

Fixed Wheel, Fixed Shaft	#44.55110
Swivel Wheel, Non-Spring Loaded Shaft	#44.55100
Swivel Wheel, Spring-Loaded Shaft	#44.55115

Becker H.D. Swivel Caster Assembly

Spring loaded swivel design for easy maneuverability with pneumatic wheels. *Sold individually.*

Caster Assembly Swivel Wheel, Spring Loaded Shaft	#44.10430
----------------------------------------------------------	------------------



OTHER DASHER COMPONENTS



Becker Dasher Support Post

Used in areas where the boards need realignment or reinforcement. Works with standard 42" high dasher boards. *Sold individually.*

External Dasher Support Post	#88.55350
-------------------------------------	------------------

Pro Series™ Machine Gate Clamp and Sling

Stainless steel with red handle. *Sold individually.*

Clamp and Sling	#100537
------------------------	----------------

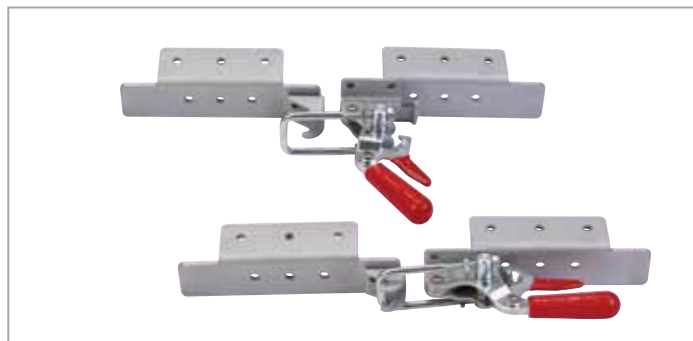

Crystaplex® Sliding Closure Bar

2" diameter x 48" long, solid steel. Four bolt on slide bar rings included for installation. Same slide bar used on straight or radius gates. *Sold individually.*

Crystaplex® Sliding Closure Bar	#102452
----------------------------------------	----------------



DASHERBOARD REPLACEMENT COMPONENTS

Precast Anchors

Athletica Sport Systems precast anchors are available in 5" and 6" heights to match the thickness of the refrigerated slabs. Anchors are 5/8" x 11 tpi thread and have an adjustable height feature. Standard design is unfinished steel base with a stainless steel plated coupling nut. Anchors are supplied complete with a 5/8" socket set screw plug.

- 5" high x 5/8"** #101986
- 6" high x 5/8"** #102317
- Pro Series Anchor** #102481



Epoxy Anchor Female Insert

Epoxy anchors are ideally suited for ice arena application where vibration, edge distances and temperature changes come into play. Standard design epoxy anchors are 5/8" x 11 tpi x 3-1/2" long, zinc plated steel finish. Anchor bolts and epoxy sold separately.



- Female Insert** #100790

Epoxy Anchors

Custom-made anchors using zinc plated steel with threaded interior sleeve.

- 1/2" x 3"** #22.10100
- 3/4" x 3 1/2"** #22.10120
- 5/8" x 2 1/2"** #22.10130
- 5/8" x 3 1/2"** #22.10140



Epoxy

Adhesive for the epoxy anchors comes in two cartridge sizes for convenient installation. Athletica Sport Systems adhesive is specially selected and proven for use in demanding ice arena applications.

28 oz tube:

Enough for 20 @ 5/8" x 3-1/2" epoxy anchors. One mixing nozzle comes with the 30 oz cartridge. The 30 oz cartridge also requires a special dispenser.

- 28 oz tube w/nozzle** #103479
- 28 oz dispenser** #103481

10 oz tube:

Enough for 7 @ 5/8" x 3-1/2" epoxy anchors. One mixing nozzle comes with the 10 oz cartridge. The 10 oz cartridge can be used with a standard size caulking gun.

- 10 oz tube w/nozzle** #103482
- Mixing nozzles** #103480



Anchor Bolts and Misc. Fasteners

We also stock various typical fasteners used in dasher board construction:

- Hex HD anchor bolts**
- Lag bolts**
- Hex nuts**
- Nylon lock nuts**
- Flat washers**
- Lock washers**



Dasher Shims

Precut aluminum shims, 1-1/2" x 5". Provide adjustment for plumbing dasher panels. Corrosion resistant and durable.

- 1/32"** #101176
- 1/16"** #101175
- 1/32"** #101526



DASHERBOARD REPLACEMENT COMPONENTS

Fasteners for Poly, Fiberglass

Keep your system from looking piece-meal by using color matched fasteners when replacing your facing, kickplate, caprail and backing. Fasteners are stocked in the following prepainted colours: Red, Dark Blue, Light Blue, Yellow, Gold.



FASTENERS

FHMS 1/4-20 x 1.0" Gr. 8 Zinc

Black	#100027	+
Blue	#100024	
Red	#100028	
White	#100001	
Yellow	#100026	
Gold	#100025	

FHMS 1/4-20 x 1.5" Gr. 8 Zinc

Black	#100031	+
Blue	#100002	
Red	#100003	
White	#100006	
Yellow	#100005	
Gold	#100004	

Wood #10 x 1.0" Zinc

1" White - Square Head	#100687	+
1" Red - Square Head	#100686	
1" Dk Blue - Square Head	#100682	
1-1/2" Yellow - Square Head	#100706	
1-1/2" Gold - Square Head	#100699	

FHMS 1/4-20 x 1.0" Type F Zinc

Blue	#100745	+
Light Blue	#100749	
Red	#100750	
White	#100758	
Yellow	#100759	
Gold	#102219	

FHMS 1/4-20 x 1.5" Type F Zinc

Blue	#100762	+
Light Blue	#100766	
Red	#100767	
White	#100775	
Yellow	#100776	
Gold	#100763	

Special Oversized Fasteners Available

These fasteners are stocked for those problem situations or where the dasher system has been damaged. Makes repairs easy and safe.



FHMS 1/4-20 x 1.5" Type F Stainless Steel

Light Blue	#100771	+
Yellow	#100774	
Gold	#100770	

FHMS 5/16-18 x 1.0" Type F Zinc

Blue	#100777	+
Red	#100779	
White	#100780	
Yellow	#100781	
Gold	#100778	

FHMS 5/16-18 x 1.5" Type F Zinc

Blue	#100782	+
Red	#100784	
White	#100785	
Yellow	#100786	
Gold	#100783	

HILO #14 x 1.0"

Blue	#100737	+
Light Blue	#100739	
Red	#100740	
Yellow	#100742	
Gold	#100738	

TEE NUT 1/4-20 x 5/16" Zinc

Tee Nut for Kickplate	#101001	+
-----------------------	---------	---

Fastener Maintenance Kit

Kit includes attic stock of the common fasteners required for routine maintenance of dasher systems. Please specify model system and caprail and kickplate colors. Also includes drill bit, countersink and drive required.

Fastener Maintenance Kit #102586



Vertical Lift Gate

Another example of the "Safety Through Innovation" thinking that keeps Athletica Sport Systems on top in the dasherboard industry. With all the standard safety and construction features we build into our gates, nothing else comes close:

- Infrared safety beam prevents the gate from descending accidentally
- If there's an obstruction, the heated safety switch located on the underside of the door will automatically force the gate to reverse back up
- Built-in mechanical safety brakes lock the gate in place should a chain fail
- Remote control included
- Manual gate control in the event of a power loss
- Follow-up annual safety inspections

We keep safety "top of mind". Why take chances with anything but the best?



Replacement Panels/Gates

Individual replacement sections can be made to fit your exact requirements. Whether your problem is damage to an existing frame or you need to add an additional access gate, we can help. Replacement sections can be made to fit wood frame, fiberglass, steel or aluminum frame systems. Call to discuss your needs.



Glass Spectator Railings

No one builds them better! Custom designed, engineer approved glass spectator railings that are sturdy, safe and always up to code. Contact us today for more information.





Basement and Backyard Rinks

If you and your family are looking to spend more time playing the great game of hockey, look no further than Athletica Sport Systems for all your rink needs. We've sold and installed backyard and basement rinks across North America and around the world.

Whether you need a rink with square or radius corners, tempered glass or lightweight acrylic, fencing or no shielding at all, we have what you need. And don't forget benches and netting too.

Contact us today for a free no-obligation quote on your own personal dasherboard system. Ask us about the many advantages of using synthetic ice.



Service

Servicing your arena boards makes good sense, and we can help. Dasher boards need to be maintained to ensure they operate in a manner that assures the safety of the skaters and hockey players who use them. Your dasher boards are the most visible features of your rink. Maintaining your boards will create a lasting impression and costs a whole lot less than replacement.

Our dasherboard technicians and installation supervisors are seasoned professionals, experienced and ready to help you keep your boards and rink equipment looking and working their best all year round. And that includes outdoor rinks too!

More than just arena services, Athletica Sport Systems offers solutions for your everyday service needs. Lift gate inspections, board and gate adjustments, re-cladding and assistance with conversions, are just some of the services we provide.

Call us for more details and a no-obligation quote.



TERMS AND CONDITIONS

Back Orders

Unless notified otherwise, we will automatically back order and ship, as soon as possible, out of stock items.

Credit Cards

Athletica Sport Systems accepts the following credit cards: Visa, MasterCard and American Express. \$3,000 limit. Applicable fees may apply.

Damaged Merchandise

When a shipment is received please inspect for damage immediately. If there is damage to the package, make notation of same on carrier paperwork before you take possession of the shipment at your premises. Athletica Sport Systems is not responsible for damage or loss in transit. All freight claims must be filed with the delivering carrier. Notification of shortages or damages must be made within five (5) days of delivery. Do not return damaged merchandise without contacting Athletica Sport Systems first.

Disclaimer

Athletica Sport Systems reserves the right to correct any errors in the catalog, remove any items that become unavailable, and to substitute similar items of equal or greater quality if available.

Past Due Payments

If payment is not made when due, interest at the rate of 18% per annum (or the maximum percentage rate allowed by law, whichever is more) will be charged on such past due payments. Purchaser agrees that Athletica Sport Systems may recover all of its attorneys' fees, costs, disbursements, expert costs, and any other related expenses incurred in the event of Purchaser's non-payment.

Pricing

Athletica Sport Systems does not supply a price list for catalog items. This policy allows us to provide customers with the best possible commodity pricing at shipment time. All applicable sales taxes are extra unless noted on quotations.

Return Policy

Prior approval is required on all returns. All returned merchandise must be new and unused, and in saleable condition, preferably in the original packaging. Return shipping costs are the responsibility of the buyer. All returns are subject to a minimum 15% restocking and handling fee. Athletica Sport Systems reserves the right to refuse the return of merchandise if our return policy and procedures are not followed. In the case of defective merchandise, contact Athletica Sport Systems to arrange return and/or replacement. Custom ordered/manufactured items shall be approved for manufacture by the buyer before construction and are not returnable.

Returns, Lost Orders, Shortages, Wrong Items

If you have placed an order and have not received it in a reasonable period, or the merchandise received is not correct, please contact us.

Shipping

All shipments, unless specified otherwise, are F.O.B. stock location. Shipping costs are additional unless quoted otherwise. Orders are shipped via LTL transport or Economy Ground Service unless directed otherwise. Expedited freight service such as Overnight and Timekeeper LTL are available upon special request.

Terms

All new accounts will require a completed signed and approved credit application. If approved on credit, payment is due net 30 days.

Warranty

All of our products have a manufacturer warranty unless specified at the time of quoting. The extent and life of warranty varies by product. Full warranty details regarding a product can be obtained by contacting us.

© 2020 Athletica Sport Systems Inc. R0120
Printed in Canada.



info@athletica.com



info@beckerarena.com



info@cascadiasport.com



Safety through innovation



WATERLOO • MINNEAPOLIS • VANCOUVER • BEIJING



Minneapolis 1.800.809.7465 Shakopee 1.800.234.5522 Vancouver 1.888.377.8000 Waterloo 1.877.778.5911 athletica.com